

**Manchester University confirms that Isaac Newton stole Laws of motion and gravity theory from Hindus.**



**In the Fifth Chapter of Vaishesika Sutra, Acharya Kanada speaks of Laws of motion and Gravity. Why do objects move? Why do They Fall? What is Inertia? What is Impulse to Motion? And so on.**

## Vaisheshika Sutra of Maharshi Kanada [5th chapter, 1st Ahnika]

[189] संयोगाभावे गुरुत्वात् पतनम् ॥ ७ ॥

*samyogābhāve gurutvāt pātanam ॥7 ॥*

In the absence of *samyoga* [contact with external forces], an object falls due to *gurutva* [mass].

Note: NEWTON's 1st law: "An object will be in uniform motion unless external force acts upon it."

[190] नोदनविशेषाभावान्नोर्ध्वं न तिर्यग्गमनम् ॥ ८ ॥

*nodana-vishesha-abhāvāt na urdhvam na tiryag gamanam*

If some external impulse [*nodana-vishesha*] is absent, an object cannot move upwards [*na urdhvam*], or backwards or sideways [*na tiryag*].

Note: NEWTON'S 2nd law: The relationship between an object's mass *m*, its acceleration *a*, and the applied force *F* is  $F = ma$ .

[191] प्रयत्नविशेषान्नोदनविशेषः ॥ ९ ॥

*prayatna-visheshāt nodana-visheshah*

## Hinduism and Science

For a particular action [*prayatna-vishesha*], there is particular reaction [*nodana-vishesha*].

NOTE: NEWTON'S 3rd law: Action and reaction are equal and opposite.

[192] नोदनविशेषादुदसनविशेषः ॥ १० ॥

*nodanaviśeṣādudasana-viśeṣah ॥10 ॥*

Some particular reaction of an object's upward motion [*udasana*] is due to special impulse [*vishesha-nodana*]



# SURROGACY mentioned in the Veda?



In Bharat, Surrogacy was known and practiced from ancient times.

Rigveda 2.18.2 - clearly mentions transfer of womb from one mother to another.

सास्मा अरं प्रथमं स द्वितीयमुतो तृतीयं मनुषः स होता ।

अन्यस्या गर्भमन्य ऊ जनन्त सो अन्येभिः सचते जेन्यो वृषा ॥ २ ॥

सः । अस्मै । अरम् । प्रथमम् । सः । द्वितीयम् । उतो इति । तृतीयम् । मनुषः । सः । होता ।  
अन्यस्याः । गर्भम् । अन्ये । ऊँ इति । जनन्त । सः । अन्येभिः । सचते । जेन्यः । वृषा ॥२॥

सः यज्ञः सोमो वा अस्रम इन्द्राय प्रथमं प्रातःसवने अरं पर्याप्तोऽभूत् । सः च  
द्वितीयं माध्यंदिने सवने पर्याप्तोऽभूत् । उतो अपि च सः तृतीयं तृतीये सवने पर्याप्तोऽभूत् ।  
मन्वय 'कालाध्वनोः' इति द्वितीया ॥ सः यज्ञः सोमो वा मनुषः मनुष्यस्य होता शभानां वोढा

anyasyāḥ garbham anya u jananta

so anyebhiḥ sachate jenyo vṛṣaḥ

word-for-word meaning

Rig Veda 2.18.2

**anyasyāḥ = of the other female**

**garbham = womb**

**anya u = another person**

**jananta = gives birth**

**so (sah) = that (womb)**

**anyebhiḥ = by other person**

**sachate = belong to**

**jenyo vṛṣaḥ = of noble origin**

Hinduism\_and\_Science



# THE THEORY OF EVOLUTION BY NATURAL SELECTION, FIRST FORMULATED IN DARWIN'S BOOK "ON THE ORIGIN OF SPECIES" IN 1859,



Evolution according to Darwin (Described in Origin of Species)



Chordates Living in Water (Fish)	Tetrapodes Living in both Water and Land (Amphibian)	Mammals Living on Land (Boar)	Partially Bipedalled Primates (Half man-Half Animal)	Hominidae Dwarf (Physically Less-Developed; Mentally very wise)	Homo Erectus (Living in Jungle) Man with Axe weapon	Homo Sapiens (The Perfect Man)
--	---	-------------------------------------	--	---	---	-----------------------------------



Evolution according to Dashavatara (Described in Vishnu Puraan)

**BUT VISHNU PURANA DATES BACK 2000 BCE SHOWS THE AVATARS OF LORD VISHNU IN SAME SEQUENCE.**

**IS THIS CONINCIDENCE ?**

# PERFECT DESCRIPTION of Heart Attack by Madhav Kar in 6th Century.



in the 6th Century, an unknown village Doctor, Mâdhav Kar, gives perfect details about heart attack in three verses.

Medical professionals will say that what that ancient doctor says is all absolutely true and perfect.

Read Caption

## Madhava Nidana

विक्षेपिकाहृद्यन्त्ररोगलक्षणम्—

हृदाक्षेपिका यत्र पीडा भवेद्भव-स विक्षेपिकाख्यो गदः संप्रदिष्टः ।

प्रजातेऽत्र रोगेऽतिघोरं नृदेहे-स्वधोभागमध्ये ह्यरोऽस्थ्नोऽधिकोष्ठम् ॥ १७ ॥

अथो वामबाहौ तथा वामभाग-स्थितांसास्थिमध्येऽपि पृष्ठप्रदेशे ।

अधिग्रीवमुग्रा भृशं प्राणममं-प्रपीडिन्यवश्यं प्रजायेत पीडा ॥ १८ ॥

समाकर्षतोदौ तथा भेददाहा-वभीक्षणं च निःश्वासरोधोऽथ मोहः ।

भृशं निर्गमः स्वेदराशेरथाध्मा-नमानाहर्णैवर्ण्यकाश्यान्त्यवश्यम् ॥ १९ ॥

स्युरत्रारुचिश्चेन्द्रियाणां क्रमेण-प्रणाशोऽपि मृत्युं लभेताजिताक्षः ।

मयेत्थं तु हृद्यन्त्ररोगोत्थितानि स्मृतानीह विद्वानि चोक्तानि कृत्स्नम् ।

उपसंहारः—

स्यरेवं भृशं हृदाक्षेपिकायां-समाख्यास्त प्रजायते पीडा यै ।

hrdâkshepikâ yatra pîdâ bhaved vai sa vikshepikâkhyo gadaḥ sampradiṣṭaḥ  
prajāte'tra roge'ti ghore nrdehe tu adhobhâga-madhye hyur-asthno,dhikoshtam.

atho vâma-bâhau tathâ vâmabhâga-stithân sâsathi-madhye'pi

prṣṭha-pradeśhe

adhi-grîvam-ugrâ bhrṣham prâṇa-marma-prapîdîni avashyam prajāyeta pîdâ

samâkarshatodau tathâ bheda-dâhâ-vabhîkṣnam ca nihshvâsa-rodho'tha mohah.

bhrṣham nirgamah svedarâsheḥ atha âdhmânâ-ânâha-vaivarṇya-kârshyânyavashyam

syuh-atrâruchis-chendriyânâm krameṇa-praṇâsho'pi mrtyum labhetâjitâkshah

Hinduism\_and\_Science



# WATER CYCLE - RISHI KANADA

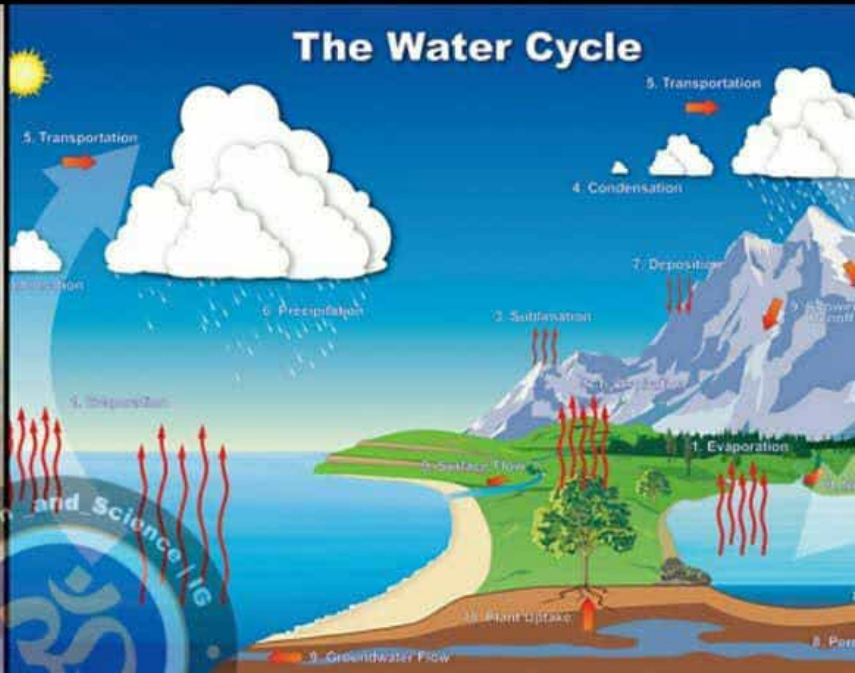

Four thousand years ago, Rishi Kanada discussed water cycle in exactly the same way in which NASA and other scientists discuss today.

Read Caption



### *Cause of rain.*

*Upaskāra.*—Now, in the section on the examination of action combined with fluid (which includes liquid) substance, he says :

**अपां संयोगाभावे गुरुत्वात् पतनम् ॥५।२।३॥**

अपां Apām, of waters. संयोगाभावे Saṁyoga-abhāve ; in the absence of conjunction. गुरुत्वात् Gurutvāt, from gravity. पतनम् Patanam, falling.

3. The falling of waters, in the absence of conjunction, is due to gravity.—

The falling of waters, in the form of a shower, is caused by gravity, which is its non-combinative cause. It takes place in the absence of conjunction, i. e., conjunction with the cloud. Therefore, absence of conjunction is the efficient cause. This is the meaning.—3.

### *Causes of flowing of water.*

*Upaskāra.*—But how is action, productive of mutual conjunction amongst the drops of water themselves, produced ? He gives the answer.

**द्रवत्वात् स्यन्दनम् ॥५।२।४॥**

द्रवत्वात् Dravatvāt, from fluidity. स्यन्दनम् Syandanam, flowing.

4. Flowing (results) from fluidity.—

By the mutual conjunction of drops of water fallen on earth, a large body of water, in the form of a stream, is produced. And the flowing or distant progression, which takes place in it, is produced from fluidity as its non-combinative cause, and from gravity as its efficient cause, in water drops which are its combinative causes.—4.

### *Cause of evaporation of water.*

*Upaskāra.*—But the falling in rain, due to gravity, would be possible, if water lying on earth went up. But how does this take place ? So he says :

**नाड्यो वायुसंयोगादारोहणम् ॥५।२।५॥**

नाड्यो Nādyah, the sun's rays. वायुसंयोगात् Vāyu-saṁyogāt, through con-

Hinduism\_and\_Science



# SPACESHIP MENTIONED IN RIG VEDA



Hinduism\_and\_Science

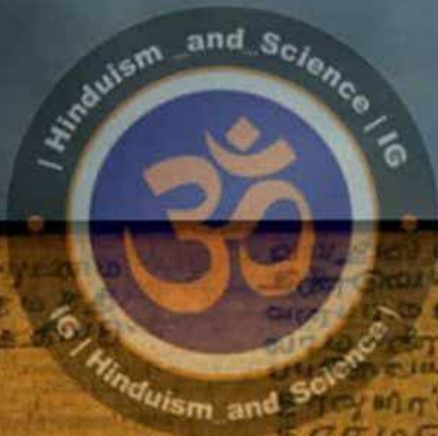

The vehicle is without horses. It has three wheels. It has no controls. It runs on verbal command. It is circular. It does not tremble while flying.

[Read Caption](#)



36

(म

वामदेवः गौतमः

छन्दः जगती 1-8, त्रिष्टुप् 9

देव

अ॒न॒श्वो जा॒तो अ॒न॒भीशु॒रु॒क्थ्यो॒र्ऽ रथ॑स्त्रि॒चक्रः॑ परि॑ वर्तते॒ रजः॑ ।  
 म॒हत्त॒द्वो॑ दे॒व्यस्य॑ प्र॒वाच॑नं॒ द्यामृ॑भवः पृथि॒र्वी यच्च॑ पु॒ष्यथ॑ ॥ 1 ॥  
 रथं॑ चे च॒क्रुः सु॒वृत्तं॑ सु॒चेत॑सोऽवि॒ह्वर॑न्तं॒ मन॑स॒स्परि॑ ध्यया ।  
 तां॑ ऊ॒ न्व॒श॒स्य॑ स॒र्वन॑स्य पी॒तय॑ आ वो॑ वाजा ऋ॒भवो॑ वे॒दया॑मसि ॥ 2 ॥

**anashvaḥ jātaḥ, anabhīśuḥ, ukthyaḥ, suvṛtam, avihvarantam, ratham, rajah, mahattadvaḥ devyasya pravāchanam dyām ṛbhavaḥ pṛthivīm yaccha puṣyatha .**  
**ratham ye chakruḥ suvṛtam suchetasah avihvarantam manasaspari dhyayā .**  
**tām u nvasya savanasya pitaye ā vah vājā ṛbhavaḥ vedayāmasi.**

### Prose Order

#### First, about the space vehicle

rathaḥ anashvaḥ, tri-chakraḥ, anabhīśuḥ, ukthyaḥ, suvṛtam, avihvarantam, rajah [antarikshe] parivartate. mahat tat. yat cha pṛthivīm puṣyatha.

The vehicle is without horses [*anashvaḥ*]. It has three wheels. It has no controls [*anabhīśuḥ*]. It runs on verbal command [*ukthyaḥ*]. It is circular [or well-balanced] [*suvṛtam*]. It does not tremble while flying [*avihvarantam*]. It is huge [*mahat tat*].

#### Next, about the makers, the Ribhus

suchetasah jātaḥ ṛbhavaḥ, vah dyām devyasya pravāchanam  
 Of great intellect born [*suchetasah*], you Ribhus. In space [*dyām*], your manufacture of the vehicle is glorified [*pravāchanam*].

#### Finally, how did they make the vehicle?

tām ratham vaḥ ye chakruḥ, manasaspari dhyayā vājā [cha]  
 That vehicle which you manufactured [*ye chakruḥ*], have made it with tremendous power of concentration [*dhyayā vājā*], and it is beyond mind [*manasaspari*].



# ANGULAR VELOCITY OF PLANETS ACCORDING TO BHASKARACHARYA

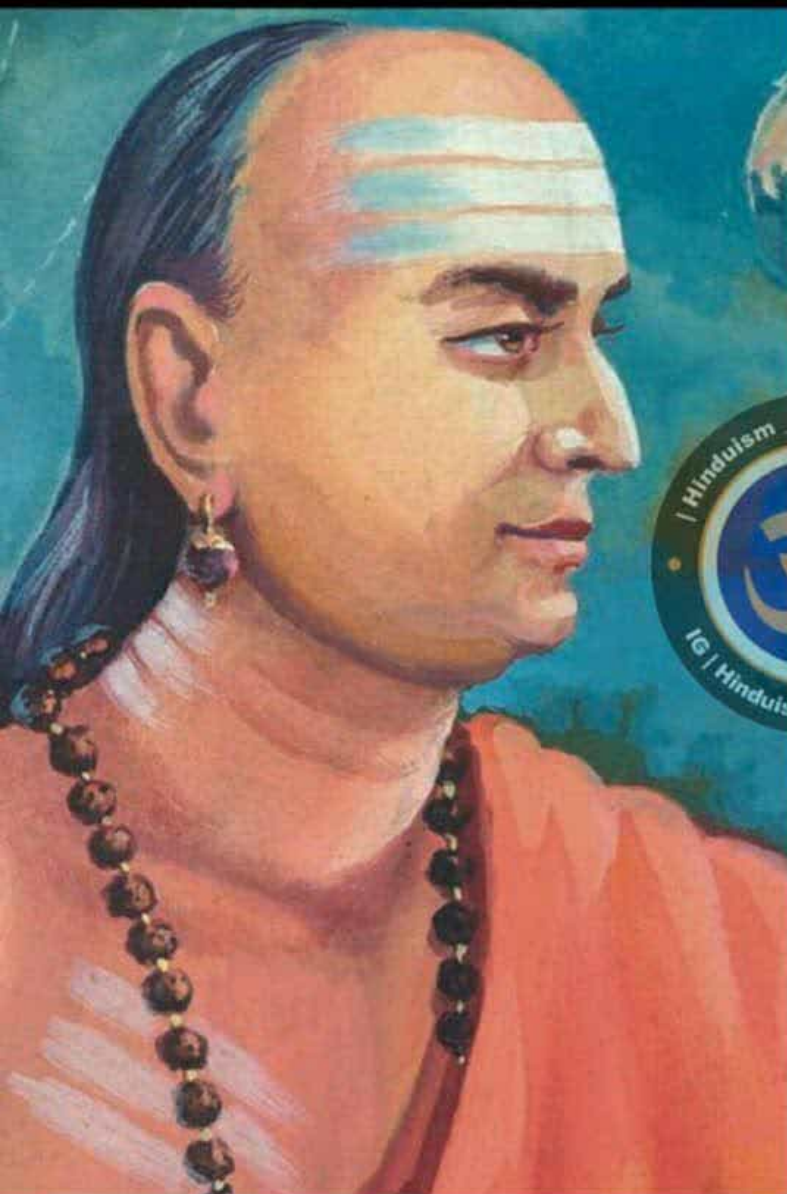

About 700 years before Newton, there lived a humble astrophysicist called Bhaskaracharya. He knew Differential Calculus. He took up difficult questions to answer. His Siddhanta Shiromani is a difficult book.

$$\therefore \frac{g^2}{g^2} = \frac{s}{s'} \\ \text{वा } \frac{g^1}{g} = \frac{\sqrt{s}}{\sqrt{s'}}$$



एतेन यस्य ग्रहस्य विम्बान्तरसूत्रं स्वरूपं भवति तस्य गतिर्महती, यस्य चाधिकं विम्बान्तरसूत्रं च ग्रहोऽल्पगतिरिति सिद्धयति । अतो वृत्ते लघ्वो लघुनि महति स्युर्महत्यश्च लिप्ता” इति भास्करोऽपि युक्तियुक्तमेव । अतः सर्वमुपपन्नम् ॥ २५-२६ ॥

इदानीमतुल्यत्वे कारणमाह ।

कक्षा सर्वा अपि दिविषदां चक्रलिप्ताङ्कितास्ता  
वृत्ते लघ्वो लघुनि महति स्युर्महत्यश्च लिप्ताः ।  
तस्मादेते शशिजभृगुजादित्यभौमेज्यमन्दा  
मन्दाक्रान्ता इव शशधराद्भ्रान्ति यान्तः क्रमेण ॥ २७ ॥

यतः सर्वा अपि कक्षाश्चक्रलिप्ताभिरेवाङ्किताः । अतो महति वृत्ते महत्यो लिप्ताः स्युः । लघुनि

Verse 27. The reason for unequal angular velocity of the planets.

Since the planetary orbits are all construed as comprising of 360° alone, a minute of arc of a smaller orbit has a smaller spatial distance which will be covered more rapidly, the velocity being constant, whereas of a longer orbit, a minute of arc means a longer distance which will be covered in a longer time at the same spatial velocity, which means that the planet appears to be slow in motion. Thus the Moon, the Mercury, Venus, Sun, Mars, Jupiter, Saturn being placed at longer distances from the earth in ascending order their orbits are longer in ascending order so that they are slower in angular motion in that order.

Here ends the section called Pratyabda Suddhi in the chapter Madhyādhikāra.

# THE EARTH'S CORE - RIG VEDA

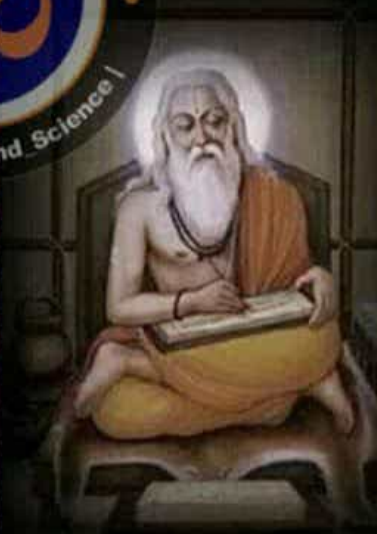
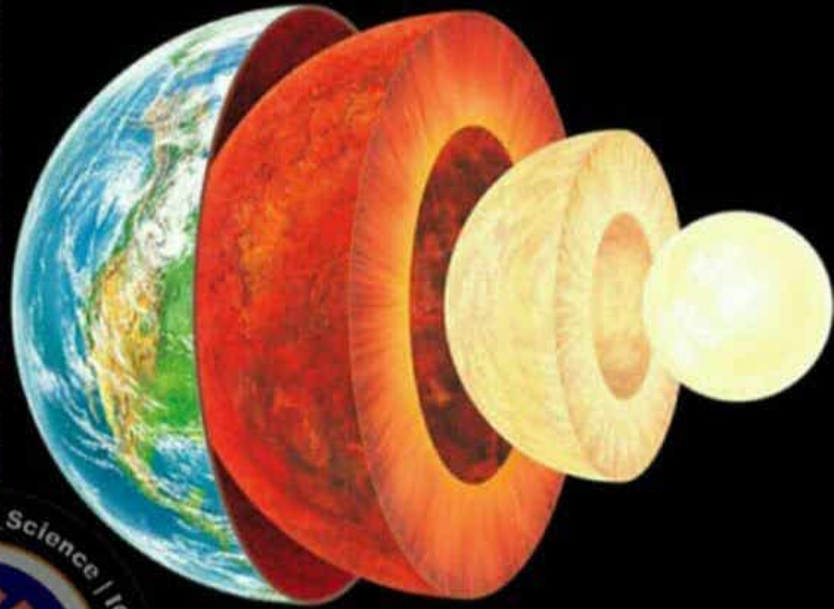

Hinduism is one of the oldest but still more scientific and modern.

Read Caption

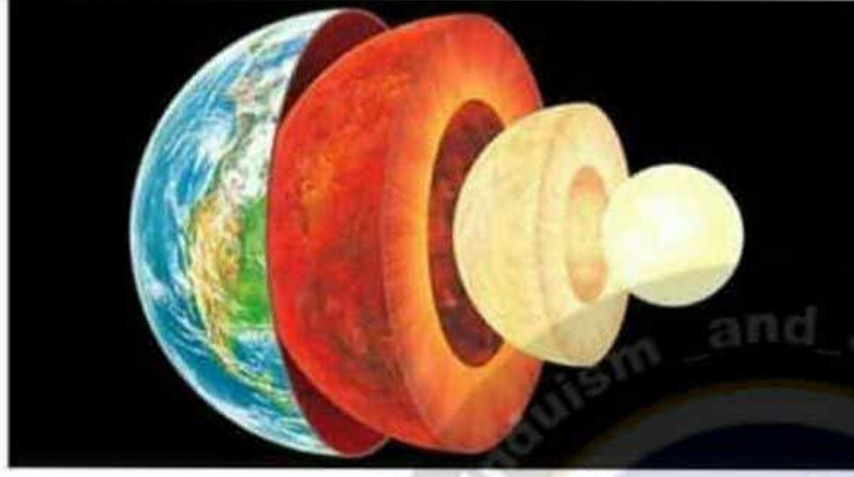

## The Earth's Core

In the Rig Veda

म. १. अ. ११. सू. ५९ ।

प्रथमोऽष्टकः

मूर्धा दिवो नाभिरग्निः पृथिव्या अथाभवदरती रोदस्योः ।

तं त्वा देवासोऽजनयन्त देवं वैश्वानर ज्योतिरिदार्याय ॥ २ ॥

मूर्धा । दिवः । नाभिः । अग्निः । पृथिव्याः । अथ । अभवत् । अरतिः । रोदस्योः ।

तम् । त्वा । देवासः । अजनयन्त । देवम् । वैश्वानर । ज्योतिः । इत् । आर्याय ॥ २ ॥

अयम् √अग्निः √दिवः द्युलोकस्य √मूर्धा शिरोवत्प्रधानभूतो भवति । √पृथिव्याः भूमेश्च √नाभिः

मंडलम् । तं त्वा देवासोऽजनयन्त देवं वैश्वानर ज्योतिरिदार्याय ॥ २ ॥

Hinduism\_and\_Science



# SUSHRUTA'S MEDICAL GENIUS

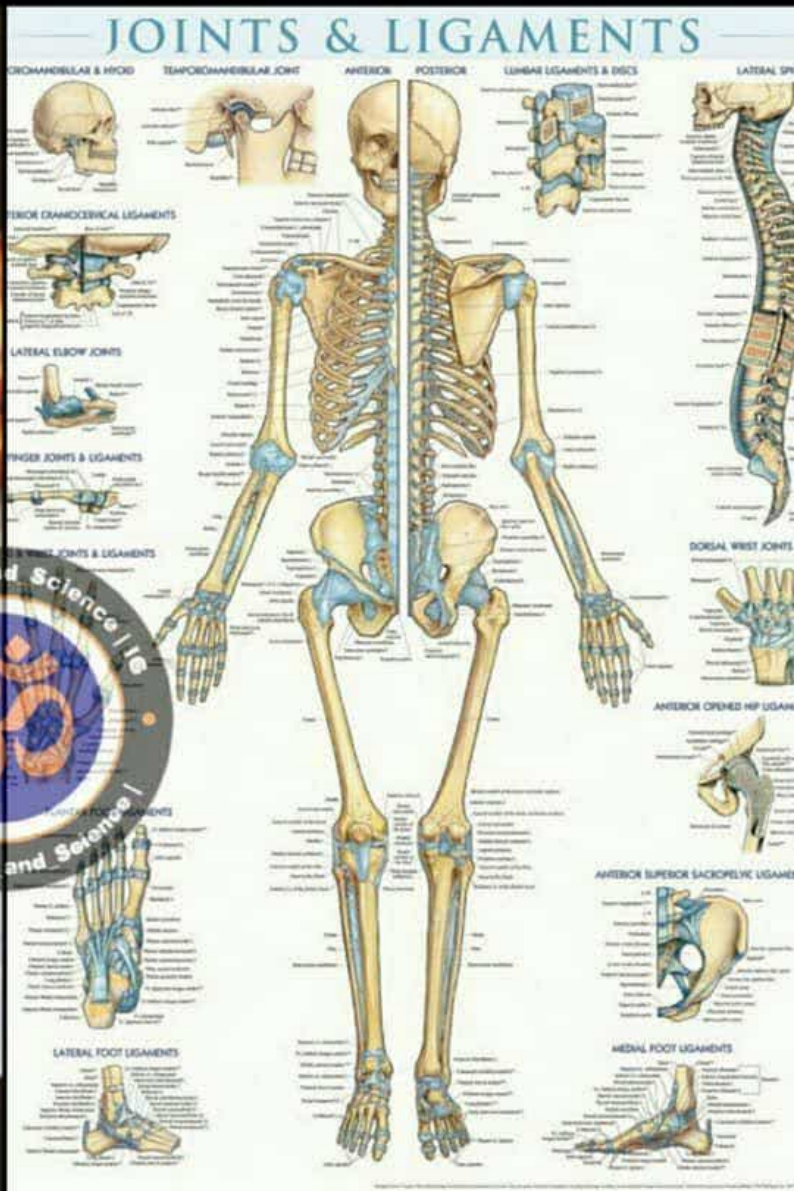

  
Hinduism\_and\_Science

Sushruta wrote in Sushruta Samhita [3000 BCE] that there are 900 ligaments in the human body. He also wrote that in some parts of the body there are four types of ligaments. Compare with modern scientific facts.



अन्स्थां तु सन्धयो ह्येते केवलाः परिकीर्तिताः

पेशीस्त्रायुसिराणां तु सन्धिसङ्ख्या न विद्यते २८

नव स्त्रायुशतानि तासां शाखासु षट्शतानि द्वे शते त्रिंशच्च कोष्ठे ग्रीवां प्रत्यूर्ध्वं

सप्ततिः एकैकस्यां तु पादाङ्गुल्यां षणिचितास्तास्त्रिंशत् तावत्य एव

तलकूर्चगुल्फेषु तावत्य एव दश जानुनि चत्वारिंशदूरौ दश वङ्गणे

शतमध्यर्धमेवमेकस्मिन् सन्धिष्वेतेनेतरसक्थि बाहू च व्याख्यातौ

षष्टिः कट्यां पृष्ठेऽशीतिः पार्श्वयोः षष्टिः उरसित्रिंशत् षट्त्रिंशद्ग्री-

वायां मूर्ध्नि चतुस्त्रिंशत् एवं नव स्त्रायुशतानि व्याख्यातानि भवन्ति २९

भवन्ति चात्र

स्त्रायुश्चतुर्विधा विद्यात्तास्तु सर्वा निबोध मे

प्रतानवत्यो वृत्तास्तु पृथ्व्यश्च शुषिरास्तथा ३०

प्रतानवत्यः शाखासु सर्वेऽपि चाप्यथ

वृत्तास्तु कण्डराः सर्वा विज्ञेयाः कुशलेऽपि ३१

आमपक्वाशयान्तेषु वस्तौ च शुषिराः खलु

पार्श्वोरसि तथा पृष्ठे पृथुलाश्च शिरस्यथ ३२

नौर्यशा फलकाग्नीर्णा तन्मनैर्त्वंदधिर्यता

nava-snâyu śatâni

śata = 100 nava = 9

nava-śata = 900

snâyū = ligament

snâyus-caturvidhâḥ

There are four types of ligaments

Hinduism\_and\_Science



# Bhaskara's Concept of the Universe

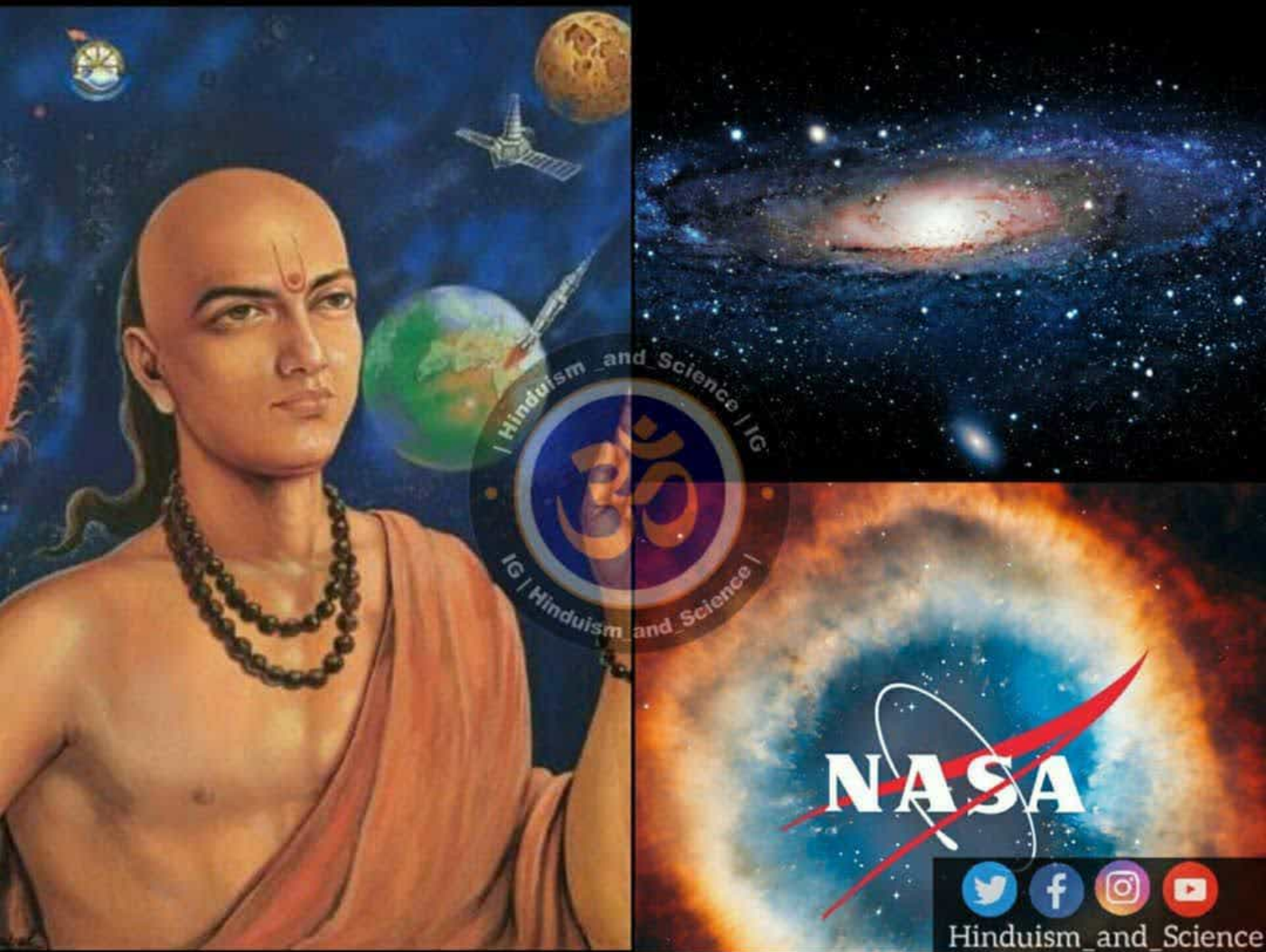

Bhaskaracharya gives the whole concept of the universe. He answers all our questions. In the universe there are stars, planets and solar systems etc.

Read Caption

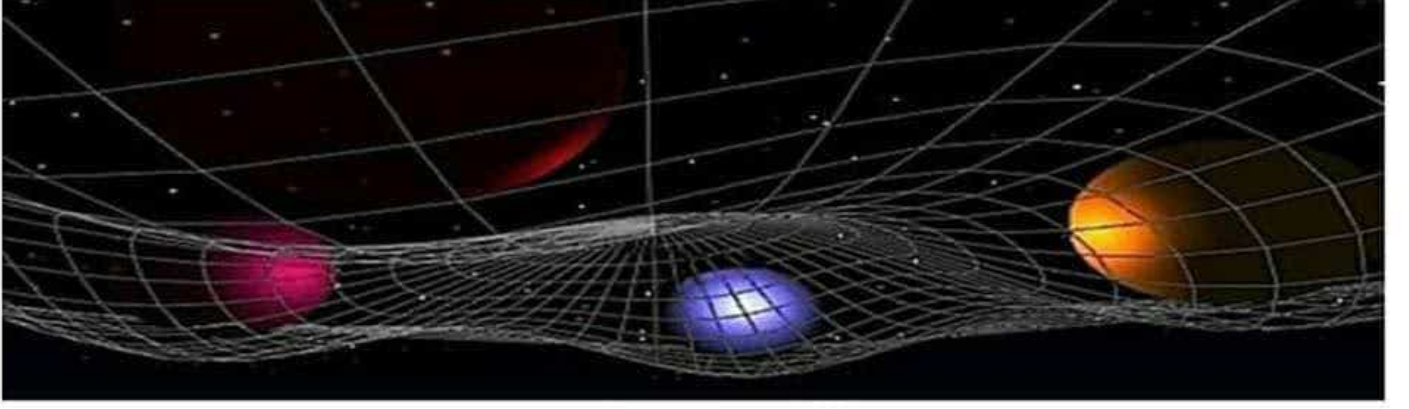

## Bhâskara's Concept of the Universe

इदानीं ज्यातःशास्त्रमूलभूतस्य सयहस्य भवक्रस्य चलन श्लाक-

द्वयेनाह ।

सृष्ट्वा भवक्रं कमलोद्भवेन  
 ग्रहैः सहैतद्भ्रमणादिसंस्थैः ।  
 शश्वद्भ्रमे विश्वसृजा नियुक्तं  
 तदन्ततारे च तथा ध्रुवत्वे ॥ १३ ॥  
 ततोऽपराशाभिमुखं भपञ्जरे  
 सखेचरे शीघ्रतरे भ्रमत्यपि ।  
 तदल्पगत्येन्द्रदिशं नभश्चरा-  
 श्रन्ति नीचोच्चतरात्मवर्त्मसु ॥ १४ ॥

वा.भा.—यदेतद्भवक्रं ग्रहैः सह भ्रमद्दृश्यते तद्विश्वसृजा जगदुत्पादकेन  
 कमलोद्भवेन ब्रह्मणा सृष्ट्वाद्वा सृष्ट्वा ततः शश्वद्भ्रमेऽनवरत्तभ्रमणे नियु-  
 क्तम् । एतदुक्तं भवति । भान्यश्विन्यादीन्यन्यानि विशिष्टानि ज्योतीर्षि  
 तेषां समूहश्चक्रं यहाश्च सूर्यादयस्तैः सह सृष्टम् । तानि भानि प्राक्-

Hinduism\_and\_Science



David Gregory gave instruction upon the Newtonian Philosophy in Edinburgh for several years prior to his removal to Oxford in 1690.

Whiston, in the memoirs of his own life, says, referring to him:—  
 “He had already caused several of his scholars to keep acts, as we call them, upon several branches of the Newtonian Philosophy, while we at Cambridge (poor wretches) were ignominiously studying the fictitious hypotheses of the Cartesians.”

The Physics of Rohault were in use to a much later period than this.

W. Brennend

# Rishi Kanada's Concept of the Relativity of Motion and time.

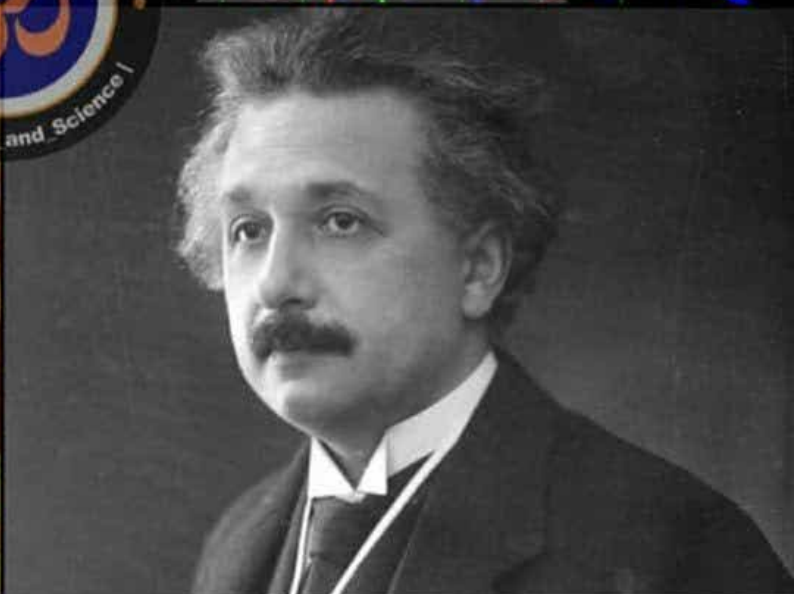
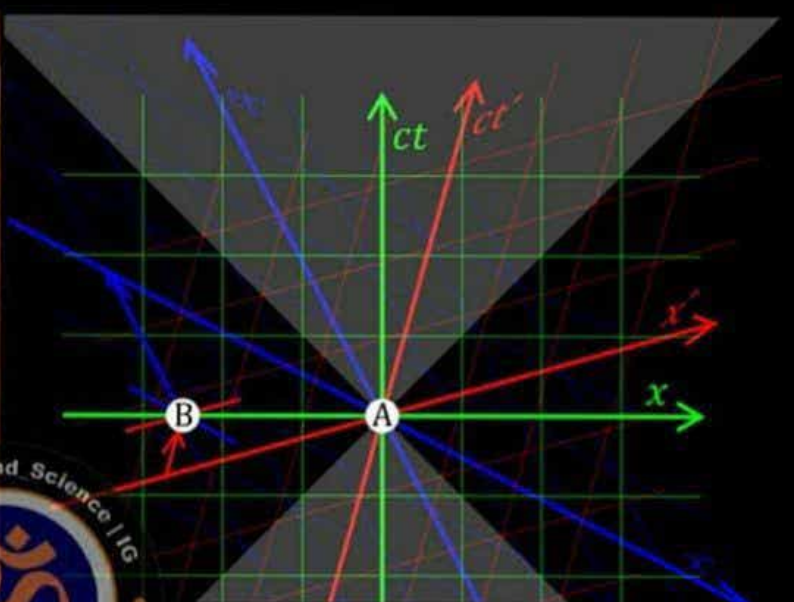
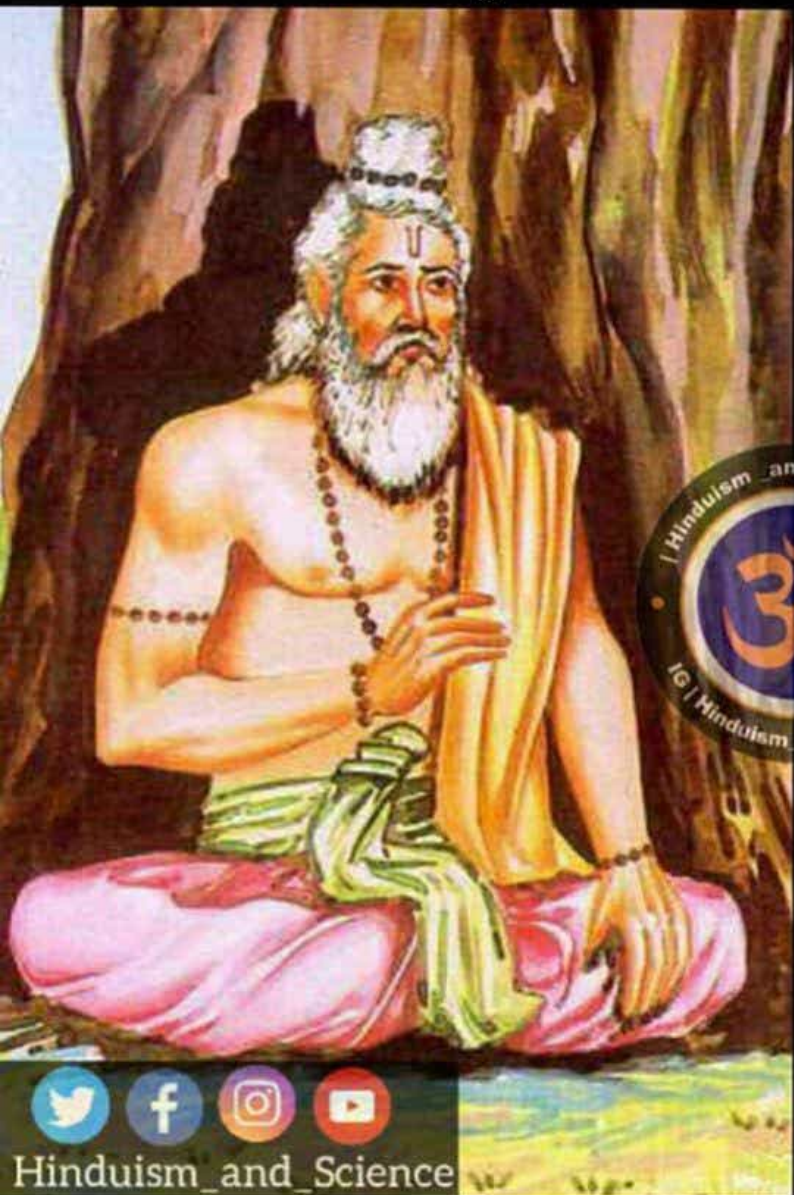

Rishi Kanada explains this concept of two-directional motion and the Relativity involved, in his laws of Relativity of time.

Read Caption

# Rishi Kaṇāda's Concept of Relativity of motion and time

1.



2.

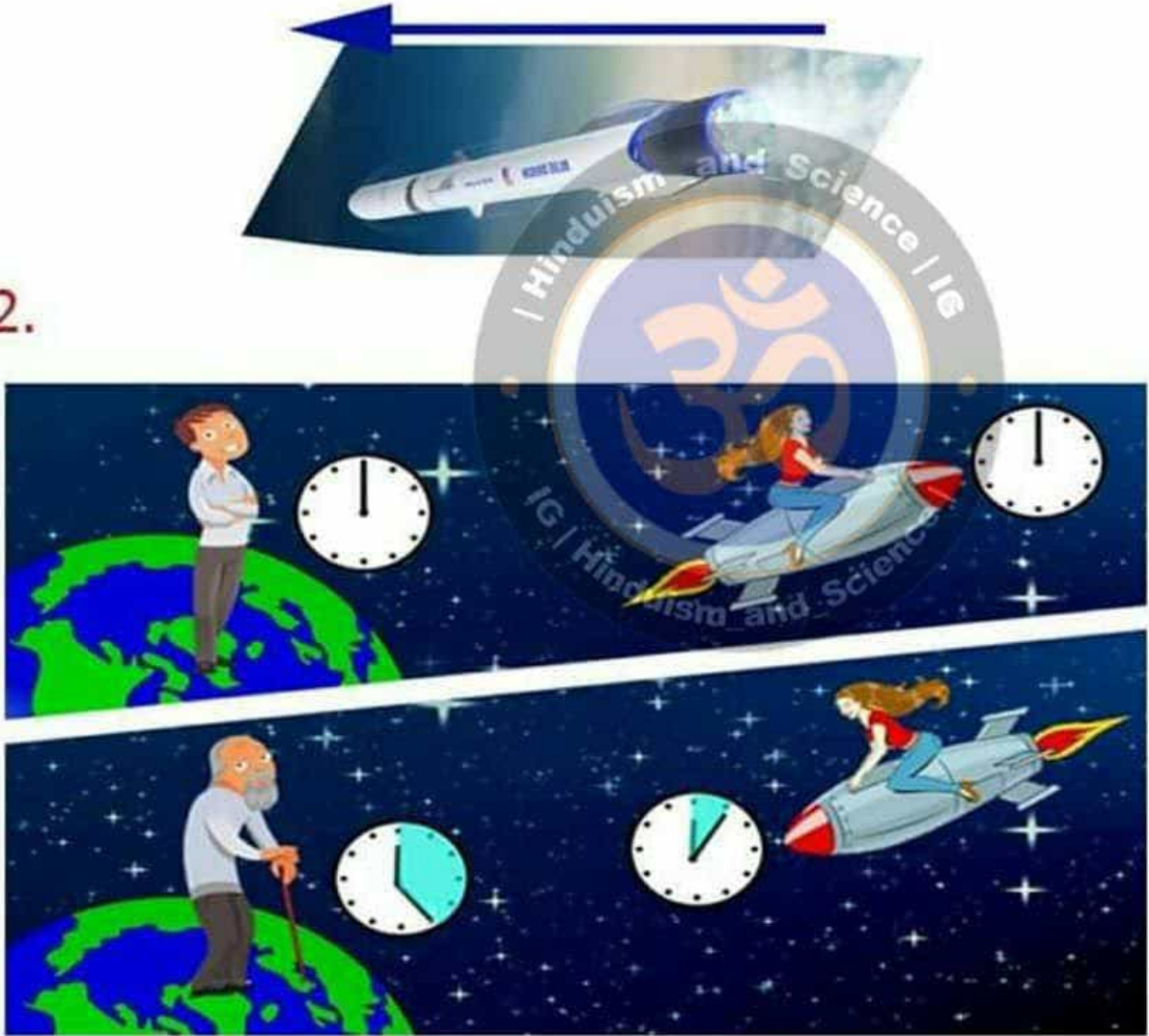

purpose of clearing up the understanding of the disciples as well as for the sake of brevity.

एकदिक्काभ्यामेककालाभ्यां सन्निकृष्टविप्रकृष्टाभ्यां परमपरञ्च  
॥ ७ । २ । २१ ॥

एकदिक्काभ्यां Eka-dikkābhyām, lying in the same direction. एककालाभ्यां Ekakālābhyām, existing at the same time सन्निकृष्टविप्रकृष्टाभ्यां Sannikṛṣṭa-vipkrāṣṭābhyām, near and remote. परं Param, prior. अपरं Aparam posterior. च Cha, and.



# Science & Spirituality of Ancient Bharat

Since many millennia we celebrate  
Maha-Kumbh every 12 years based  
on Brahaspati cycle



While West came to know just few  
centuries ago, Our Ancients knew 1000s  
of years ago that Jupiter (Brahaspati)  
completes one cycle around Sun in 12 years

Concept of GRAVITY was introduced by "Varāhamihira"

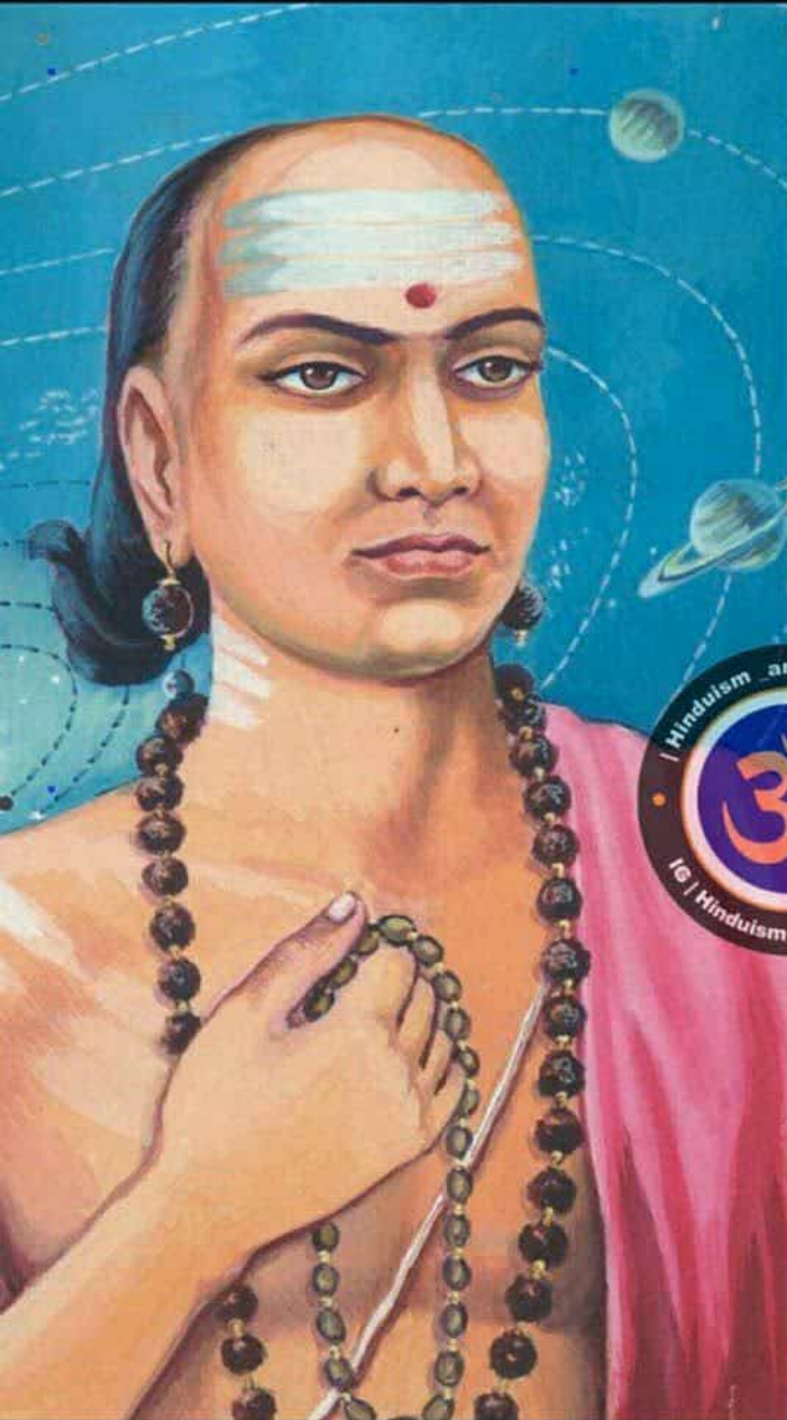

Hinduism\_and\_Science

But no one knows about it only name we know is "Isaac Newton"

## अपां संयोगाभावे गुरुत्वात् पतनम् ॥५।२।३॥

अपां Apām, of waters. संयोगाभावे Saṁyoga-abhāve ; in the absence of conjunction. गुरुत्वात् Gurutvāt, from gravity. पतनम् Patanam, falling.

3. The falling of waters, in the absence of conjunction, is due to gravity.—201.

The falling of waters, in the form of a shower, is caused by gravity, which is its non-combinative cause. It takes place in the absence of conjunction, i. e., conjunction with the cloud. Therefore, absence of conjunction is the efficient cause. This is the meaning.—3.

*Causes of flowing of water.*

*Upaskāra.*—But how is action, productive of mutual conjunction amongst the drops of water themselves, produced ? He gives the answer.

## संयोगाभावे गुरुत्वात् पतनम् ॥ ५ । १ । ७ ॥

संयोगाभावे Saṁyoga-abhāve, in the absence of conjunction. गुरुत्वात् Gurutvāt, from gravity. पतनम् Patanam, falling.

7. In the absence of conjunction, falling (results) from gravity.—187.

By the term, 'conjunction,' every kind of impediment is indicated. Hence in the absence of impediments, in consequence of gravity as its non-combinative cause, falling i. e., an action resulting in conjunction below, is produced. Here in fruit, etc., possessing gravity, the impediment is conjunction ; in a bird, etc., however, volition to hold up is the impediment to falling ; in an arrow, etc., when discharged, it is the reaction that is the impediment to falling. The meaning is that, in the absence of these, falling is caused by gravity. In the case of holding up of poison, etc., in the air, by thought-transference, etc., conjunction with the soul endowed with *adṛiṣṭānti* (invisible after-effects of previous acts), or *mantra*, and the like are really the impediments. These also are included by the term 'conjunction.'—7.

*Bhāṣya.*—reads *Samskāra* in the place of *Samyoga*.

*Falling how produced—continued.*

*Upaskāra.*—Will, if falling is caused by gravity, then how can there be sometimes an upward, and sometimes a sideward motion in a stone, etc., when thrown up ? To meet this objection, he says :

Hinduism\_and\_Science





Did you know ?

108

interesting  
facts

The holiest number for Hindus is 108. This is the ratio of Sun's distance (from Earth)/Sun's diameter or Moon's distance (from Earth)/Moon's diameter. Thus, most of our prayer beads have 108 beads .



Sri Yantra (OM) Mandala



OM sound on a Tonoscope

## Science proving the Rishi's Right.

A comparison of the similarities between the Sri Yantra Mandala and a Tonoscope picture of the sound OM. The Sri Yantra mandala is thousands of years old



Sri Yantra (OM) Mandala



OM sound on a Tonoscope

## Science proving the Rishi's Right.

A comparison of the similarities between the Sri Yantra Mandala and a Tonoscope picture of the sound OM. The Sri Yantra mandala is thousands of years old

3 Vaisheshika Sutras proposed many years before Newton's Three Laws of Motion 🙏 🌀

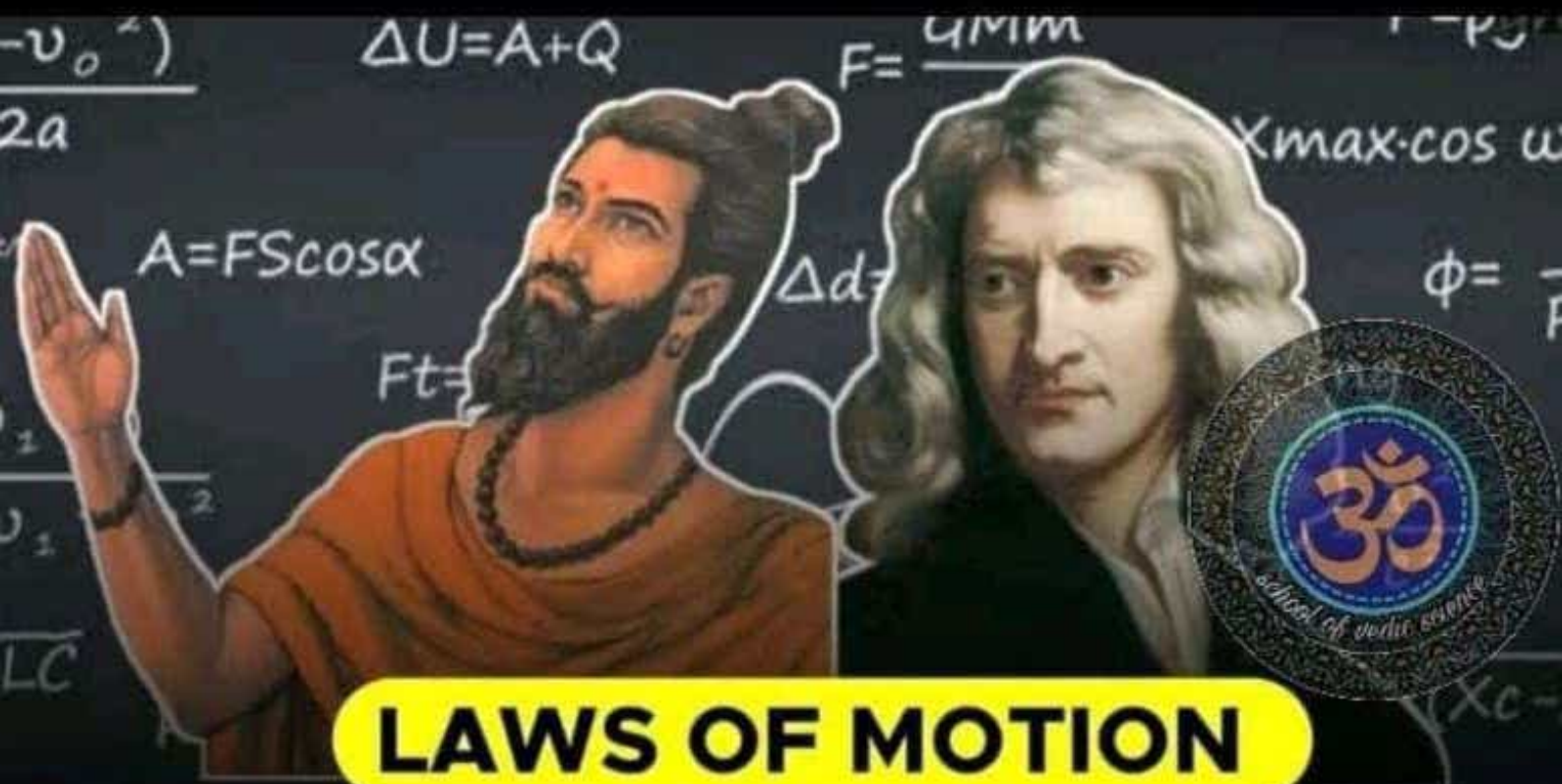

**LAWS OF MOTION**

**SAGE KANAD VS NEWTON**

Must read and share 🙏

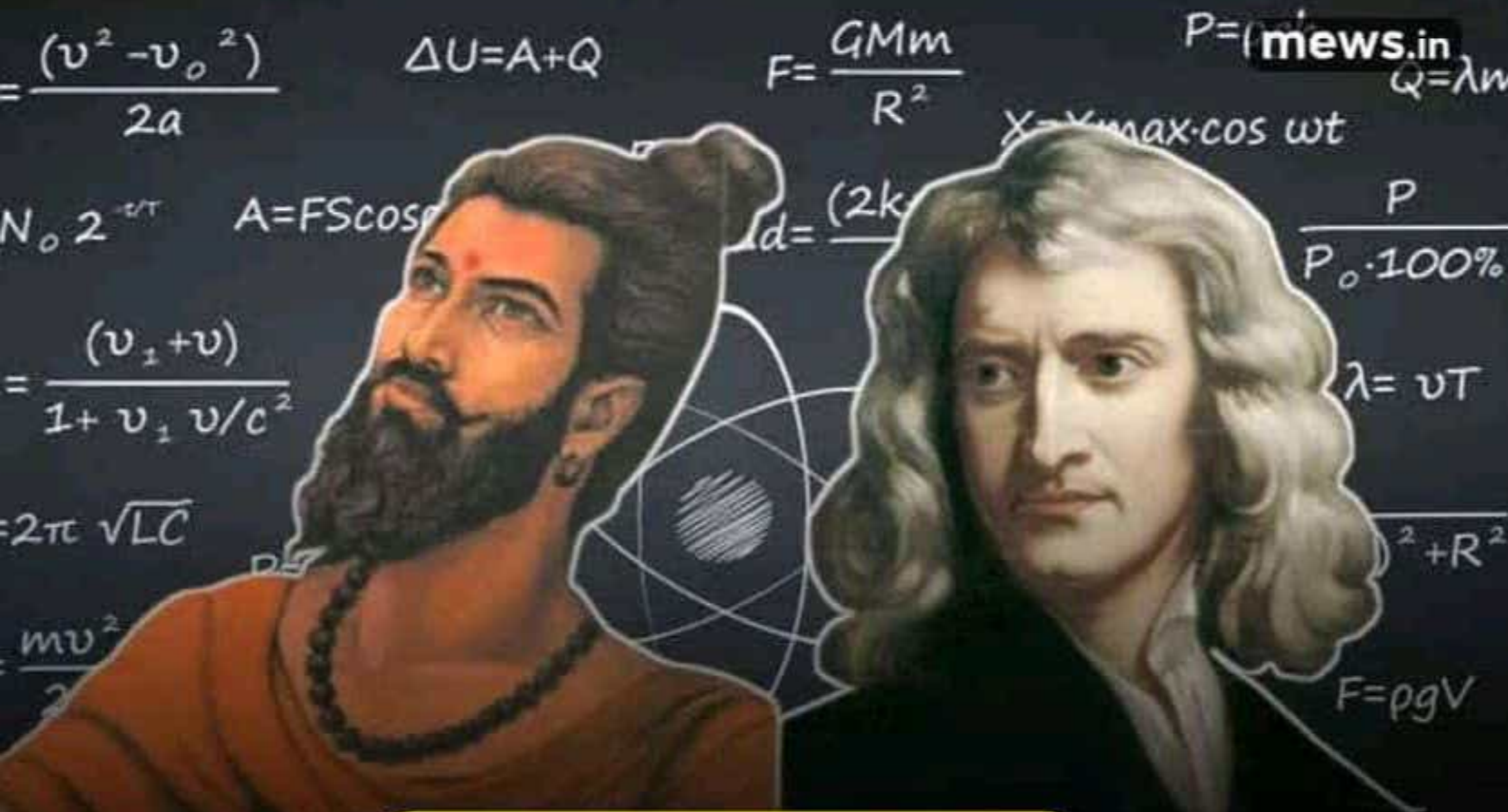

**First law of Motion -**

**By Sage Kanada** - वेगः निमित्तविशेषात् कर्मणो जायते ।  
Translation : Change of motion is due to impressed force.  
(6th century BC)

**By Newton** - Every object moves in a straight line unless acted upon by a force.  
(16th century AD)

$$= \frac{(v^2 - v_0^2)}{2a}$$

$$\Delta U = A + Q$$

$$F = \frac{GMm}{R^2}$$

$$P = \rho m v$$
  
$$Q = \lambda w$$

$$N_0 2^{-vt}$$

$$A = FS \cos \theta$$

$$d = \frac{(2k)}{...}$$

$$x = x_{max} \cdot \cos \omega t$$

$$\frac{P}{P_0 \cdot 100\%}$$

$$= \frac{(v_2 + v)}{1 + v_1 v/c^2}$$

$$= 2\pi \sqrt{LC}$$

$$\frac{mv^2}{2}$$

$$\lambda = vT$$

$$^2 + R^2$$

$$F = \rho g V$$

## Second law of Motion -

**By Sage Kanada** - वेगः निमित्तापेक्षात् कर्मणो जायते  
नियतदिक क्रियाप्रबन्धहेतु ।

**Translation** : Change of motion is proportional  
to the impressed force and is in the direction  
of the force. (6th century BC)

**By Newton** - The acceleration of an object is  
directly proportional to the net force exerted  
and inversely proportional to the object's  
mass. (16th century AD)

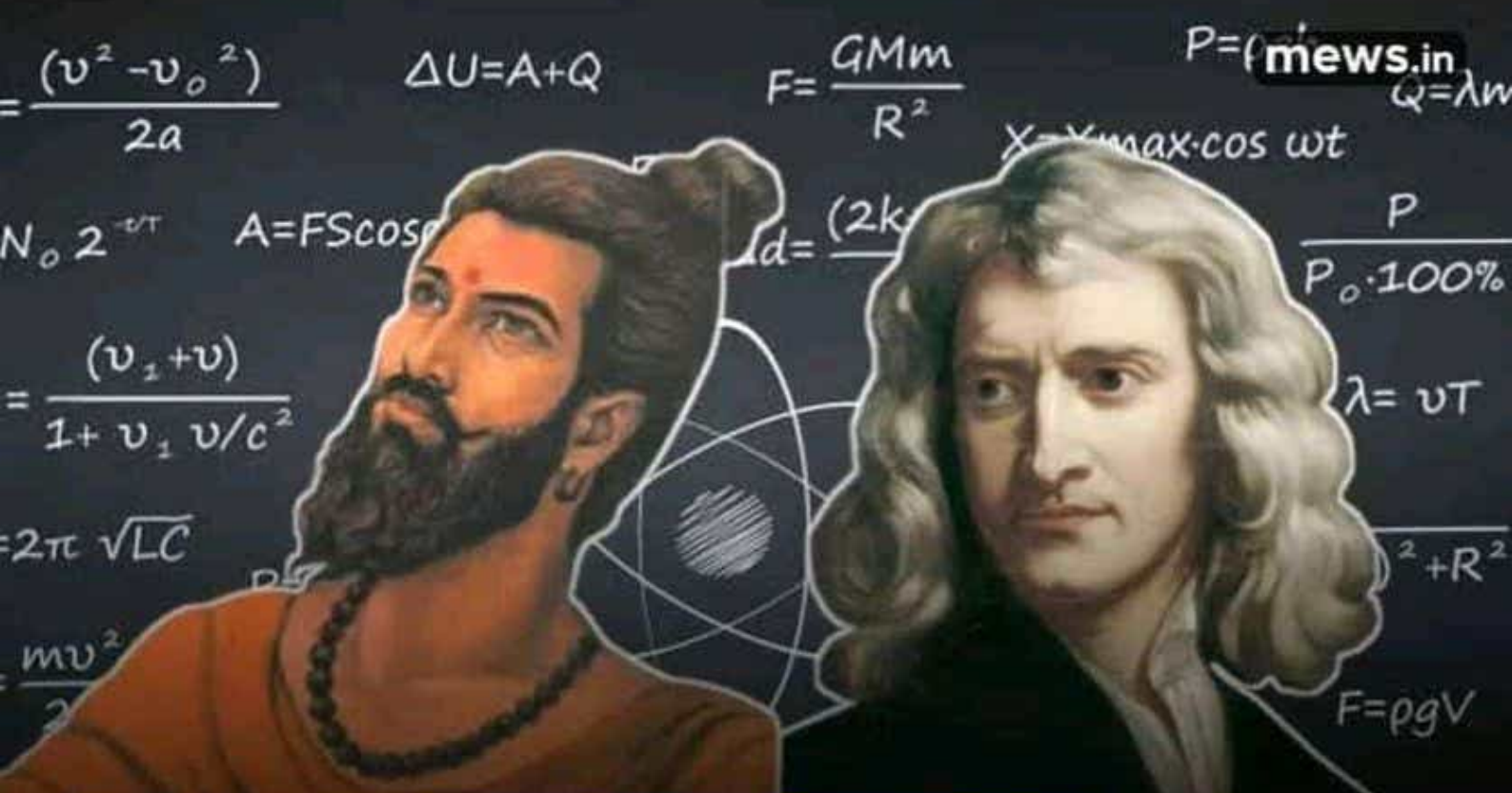

**Third law of Motion -**

**By Sage Kanada** - वेगः संयोगविशेषविरोधी ।  
Translation : Action and reaction are equal and opposite.  
(6th century BC)

**By Newton** - For every action, there is an equal and opposite reaction.  
(16th century AD)

## Secret of Vedas

# Similarity in Hinduism & Quantum Physics

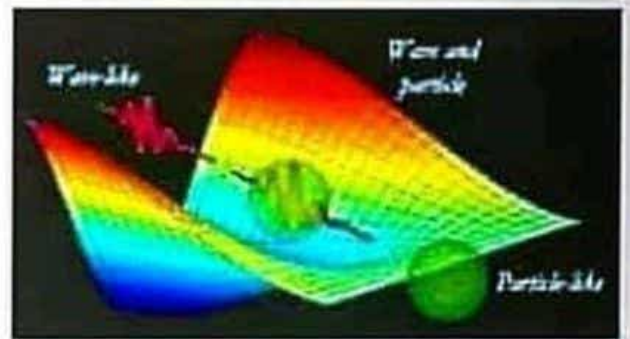

॥ देवी भागवतपुराण ॥

Srimad Devi Bhagwat Purana

"Shakti is Both  
Saguna (with  
form ) &  
Nirgunan  
(without form )

" ancient science

$$i\hbar \frac{\partial}{\partial t} \Psi(\mathbf{r}, t) = \left[ \frac{-\hbar^2}{2\mu} \nabla^2 + V(\mathbf{r}, t) \right] \Psi(\mathbf{r}, t)$$

"Every elementary  
entity may exhibit  
both  
Particle behaviour  
(with form )  
&  
Wave behaviour  
(without form ) "



# New light on birth of the universe

Observations of Cosmic Microwave Background (CMB) radiation – the afterglow of the Big Bang itself – reveal that the newborn universe inflated a trillion trillion trillion times within the blink of an eye. The European Space Agency's Planck space telescope also shows there is less of the perplexing dark energy and more dark matter in the universe than previously known



Oldest light: Universe is about 80 million years older than previously thought

## Structure of the universe

Before Planck mission | After Planck mission

Ordinary matter  
4.5% | 4.9%

Dark matter	22.7%	Dark matter	26.8%
Dark energy	72.8%	Dark energy	68.3%

Pictures: European Space Agency, NASA, AFP/Getty Images  
© GRAPHIC NEWS



**1** Big Bang: In a searing fireball with temperature of  $10^{32}$  degrees Kelvin, or 100,000 billion billion degrees, universe expands faster than speed of light

**2** One second later: Temperature falls to 10 billion degrees. Atomic nuclei form

**3** 100 seconds later: Temperature falls to 1 billion degrees. Fundamental particles and radiation are linked together

**4** 380,000 years after Big Bang: Temperature falls to 3,000 degrees. Atoms of hydrogen formed. Radiation and matter travel freely for first time – CMB radiation is released, preserving record back to this time

**5** Dark Ages: Stars have not yet been born – there is no other light except CMB afterglow

**6** 200 million years after Big Bang: First stars and galaxies form

**7** Nine billion years after Big Bang: Our Sun is formed from collapse of cloud of gas and dust in the Milky Way galaxy. 500 million years later Earth is formed from leftovers

**8** Today: 13.82 billion years after Big Bang

# REASON BEHIND

## SITTING ON FLOOR WHILE EATING



**THIS TRADITION IS NOT JUST ABOUT SITTING ON FLOOR AND EATING, IT IS REGARDING SITTING IN THE "SUKHASAN" POSITION AND THEN EATING. SUKHASAN IS THE POSITION WE NORMALLY USE FOR YOGA ASANAS. SITTING IN THIS POSITION WHILE EATING HELPS IN IMPROVING DIGESTION AS THE CIRCULATORY SYSTEM CAN FOCUS SOLELY UPON DIGESTION AND NOT ON OUR LEGS DANGLING FROM A CHAIR OR SUPPORTING US WHILE WE ARE STANDING.**

**DID YOU KNOW**

**MAHARISHI KANAD**

**AN ANCIENT INDIAN SAGE, SCIENTIST AND PHILOSOPHER PROPOUNDED A THEORY OF ATOMS TO EXPLAIN THE CREATION AND EXISTENCE OF THE UNIVERSE**

**BUT THE DISCOVERY OF ATOMIC THEORY IS ATTRIBUTED TO JOHN DALTON, AN ENGLISH CHEMIST, PHYSICIST, AND METEOROLOGIST**

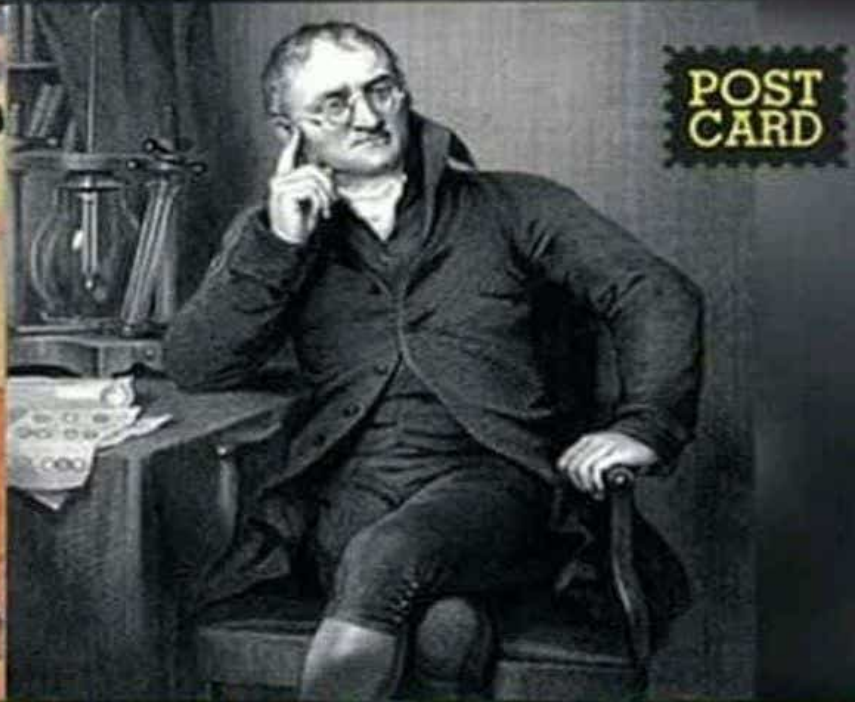
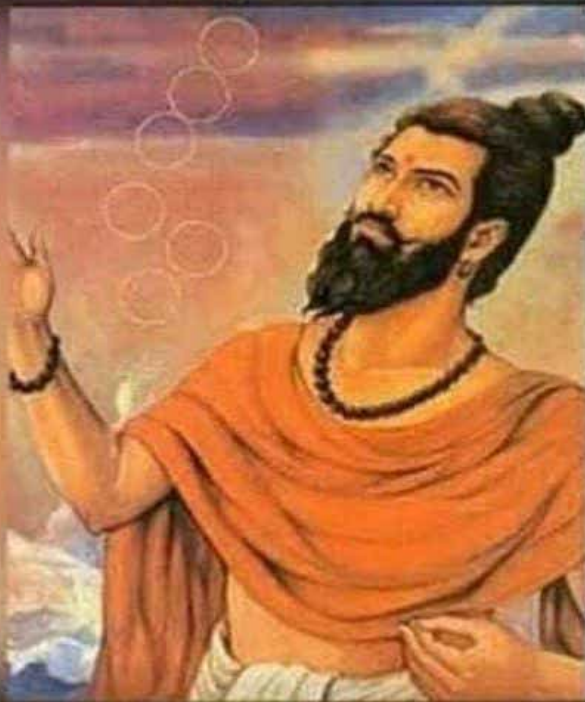

**OUR ANCIENT RISHIS FIRST CONCEPTUALIZED THE IDEA THAT MATTER CONSISTS OF INDIVISIBLE UNITS AND CANNOT BE FURTHER DIVIDED INTO SMALLER PARTICLES**

**Maharishi Kanada** invented **atomic theory** at least **2500 years** before **John Dalton**, before 600 BC

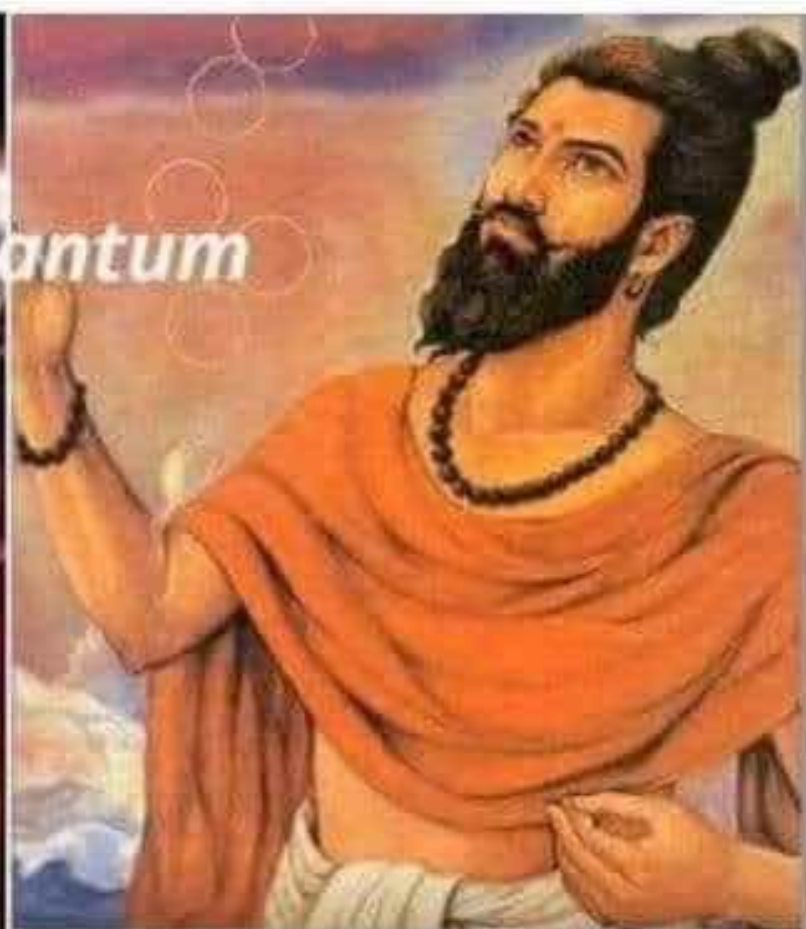

He stated that **the smallest indivisible** form of matter is **parmanu**. He even explained the **dimensions, motions** and even the **chemical reactions** of parmanu and its compound forms

# Madhava Namputiri

The Man who disrupted Calculus

Madhava Namputiri is an Indian Mathematician & Astronomer during 13<sup>th</sup> Century from Kerala. His contributions to the field of Calculus are highly disruptive and revered even today. Back then, Kerala was the Spice hub for the trade into Europe and potentially there was a flow of knowledge from India to Europe.

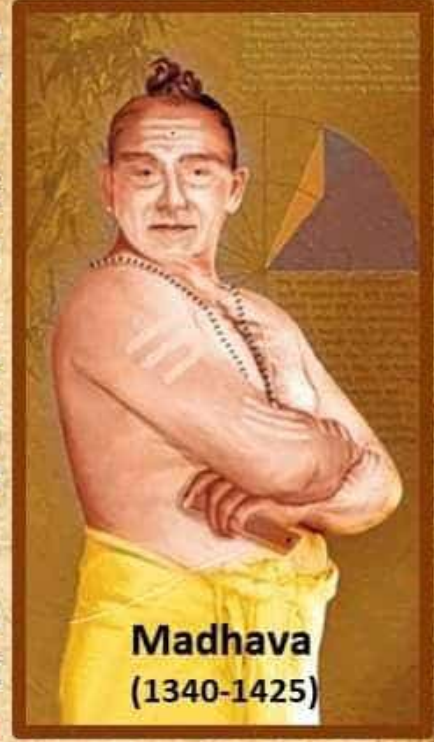

Madhava  
(1340-1425)

Later in 17<sup>th</sup> Century, Sir Issac Newton and Gottfried Leibniz further developed Calculus. Even

today, in the honour of Madhava, in the field of Calculus, his models are named as MADHAVA SERIES.

Calculus is a branch of Mathematics that deals with predicting the outcome of a simulation in various fields right from Economics, Biology, up until launching Satellites & Space Travel. Madhava's works are the basis for predictive analysis even today.

As an Astronomer, he also invented mathematical models to calculate the position of Moon accurately for every 36 minutes. He was also the 1<sup>st</sup> to calculate the value of Pi as 3.1415926535922 which is very close to 3.141592653589793, the value used in space expeditions today. He gave the formula for Pi in the form of below slokam in the book Kriya Kramakari.

व्यासे वारिधिनिहते रूपहते व्याससागराभिहते ।  
त्रिशरादिविषमसङ्ख्याभक्तमृणं स्वं पृथक् क्रमात् कुर्यात् ॥

$$\pi = 4 \left( 1 - \frac{1}{3} + \frac{1}{5} - \frac{1}{7} + \dots \right)$$



PROJECT  
SHIVOHAM



## Why do we worship Tulsi plant in Hindu culture?



Tulsi is considered as a mother by Hindus, it has many medicinal properties. Tulsi is an antibiotic, consuming basil every day can give you a long and healthy life as the plant prevents diseases & stabilizes health. Tulsi gives out oxygen for 20 hours and Ozone for four hours a day along with the formation of nascent oxygen which absorbs harmful gases. It is also believed that snakes do not tread near Tulsi plant, due to this reason ancient people used to plant Tulsi near their houses.



# Scientific significance of a Temple Bell



www.vedicgyaan.com

It is not just your ordinary metal. It is made of various metals including cadmium, lead, copper, zinc, nickel, chromium & manganese. The proportion at which each one of them mixed is real science behind a bell. Each of these bells is made to produce such a distinct sound that it can create unity of your left & right brain. The moment you ring that bell, bell produces sharp but lasting sound which lasts for minimum of seven seconds in echo mode good enough to touch your seven chakras in your body.

# ROBOTICS IN ANCIENT BHARAT



King Bhoja, of the Paramara clan, wrote 1000 years ago in Samarangana Sutradhara, That we can make mechanically moving robots.

[Read Caption](#)



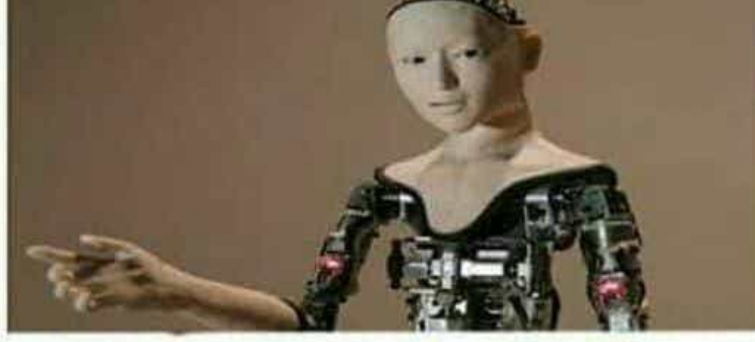

## Robotics in Ancient India

1. दृग्ग्रीवातलहस्तप्रकौष्ठवाहुरुहस्तशाखादि ।  
सच्छिद्रं वपुरखिलं तत्सन्धिषु खण्डशो घटयेत् ॥ १०१ ॥
2. श्लिष्टं कीलकविधिना दारुमयं सृष्टचर्मणा गुप्तम् ।  
पुंसोऽथवा युवत्या रूपं कृत्वातिरमणीयम् ॥ १०२ ॥
3. रन्ध्रगतः प्रत्यङ्गं विधिना नाराचसङ्गतैः सूत्रैः ।  
ग्रीवाचलनप्रसरणविकुञ्चनादीनि विदधाति ॥ १०३ ॥
4. करग्रहणताम्बूलप्रदानजलसेचनप्र(माणा?णामा)दि<sup>१</sup> ।  
आदर्शप्रतिलोकनवीणावाद्यादि च करोति ॥ १०४ ॥
5. एवमन्यदपि चेदृशमेतत् कर्म विस्मयविधायि विधत्ते ।  
जृम्भितेन विधिना निजबुद्धेः कृष्टमुक्तगुणचक्रवशेन ॥ १०५ ॥
6. पुंसो दारुजर्मूर्ध्वं रूपं कृत्वा निकेतनद्वारि ।  
तत्करयोजितदण्डं निरुणद्धि प्रविशतां वर्त्म ॥ १०६ ॥
7. खड्गहस्तमथ मुद्गरहस्तं कुन्तहस्तमथवा यदि तत् स्यात् ।  
तन्निहन्ति विशतां निशि चौरान् द्वारि संवृतप्रखं प्रसभेन ॥ १०७ ॥
8. ये चापाद्या ये<sup>२</sup> शतघ्न्यादयोऽस्मिन्नुष्टग्रीवाद्याश्च दुर्गस्य गुप्त्यै ।  
ये क्रीडाद्याः क्रीडनार्थं च राज्ञां सर्वेऽपि स्युर्योगतस्ते गुर्णानाम् ॥

# NO DOCTOR WILL LAUGH AT SUSHRUTA TODAY

5000 YEARS AGO Sushruta wrote in  
his Encyclopedia of Medicine that

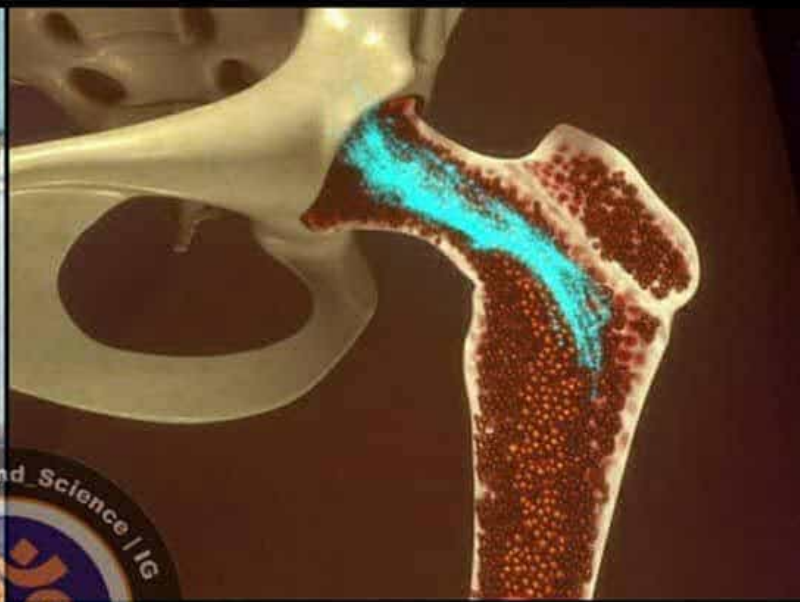
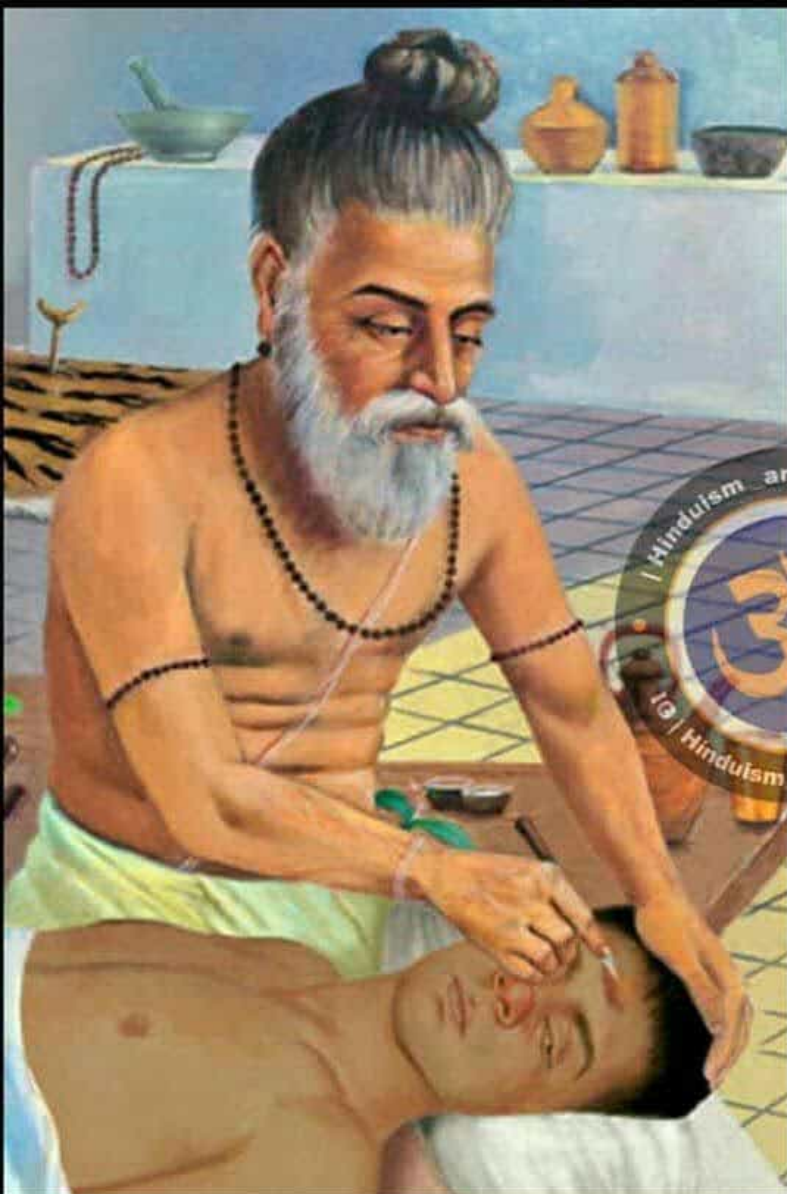

- 1) Bones are vital to the body because **BONE MARROW** produces live-saving essence.
- 2) Muscles are bound to the bones using tendons.

[Read Caption](#)

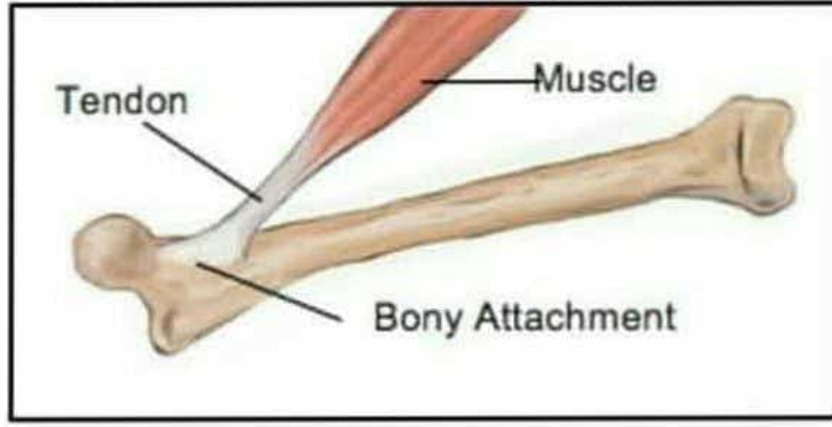

सुश्रुतसंहिता

शारीरस्थान

भवन्ति चात्र

1. अभ्यन्तरगतैः सारैर्यथा तिष्ठन्ति भूरुहाः  
अस्थिसारैस्तथा देहा ध्रियन्ते देहिनां ध्रुवम् २१  
तस्माच्चिरविनष्टेषु त्वङ्गांसेषु शरीरिणाम्  
अस्थीनि न विनश्यन्ति साराण्येतानि देहिनाम् २२
2. मांसान्यत्र निबद्धानि सिराभिः स्नायुभिस्तथा  
अस्थीन्यालम्बनं कृत्वा न शीर्यन्ते पतन्ति वा २३  
मन्धरायति तितिघ्राश्रेणानन्तः शिगश्च २४

**SUSHRUTA SAMHITA**

1. Just as a tree [*bhūruha*] stands due to the internal sap [*abhyantara-sâra*], bodies keep beings [*dehinâm*] firm and alive due to the bone marrow [*asthi-sâra*].

Therefore, even if the skin and flesh of living beings are lost permanently, the bones are not lost. Bones are the essence of living beings.

2. The flesh [*mâmsa*] is tied or bound to the bones by tendons [*sirâ*].

# Did You Know? **E=MC<sup>2</sup>**

Einstein formula is well known regarding energy and mass relationship as per his Mass Energy Equivalence  $\Delta E = (\Delta M)C^2$  What it means that every mass has energy and energy could be massless. Energy and Mass are interchangeable. Many are unaware that Gita has already told us with a dedicated verse.

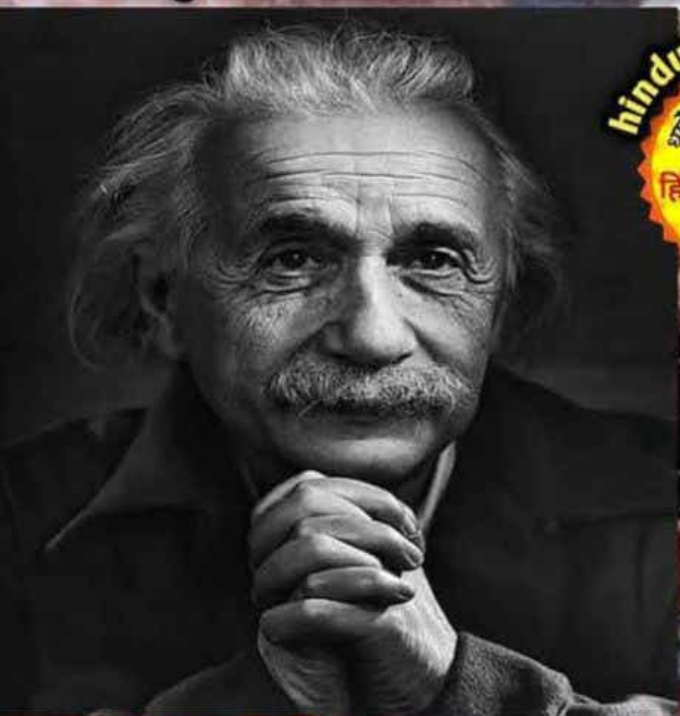

**Einstein once said "When I read the Bhagavad-Gita and reflect about how God created this universe everything else seems so superfluous."**

Today people believe in only modern science, whatever be it truth or simply a baseless theory. But when it comes to ancient and vedic science they don't believe.

**Swipe To See** 

**bhūmir āpo 'nalo vāyuh  
kham̐ mano buddhir eva ca  
ahañkāra itīyaṁ me  
bhinnā prakṛtir aṣṭadhā ||**  
Srimad Bhagavad Gīta, Chapter 7, Verse 4

**MEANING : Earth, water, fire, air, ether, mind, intelligence and false ego—all together these eight constitute My separated material energies.**

**Thus, this mass–energy relation states that the universal proportionality factor between equivalent amounts of energy and mass is equal to the speed of light squared. This also serves to convert units of mass to units of energy, no matter what system of measurement units is used.**

**Krishna said in Gīta that, Soul can neither be created nor destroyed. It just transfers from one body to another, that is from one form to another or one body to another.**

**Many years later, science said, Energy can neither be created or nor be destroyed it can only be changed from one form to another.**

**This proves that soul is nothing but energy and body is just a mass so when death happens, mass is converted to massless energy-called soul**



## Shloka:

Chandro jalam arko'gnirmRid bhUsh chhAyApi yA tamastaddhi |  
ChhAdayati shashi sUryam shashinam mahatI cha bhUch chAyA ||

Source: Aryabhatiyam, Golapadah, Chapter4, Slokha 37 (499 AD)

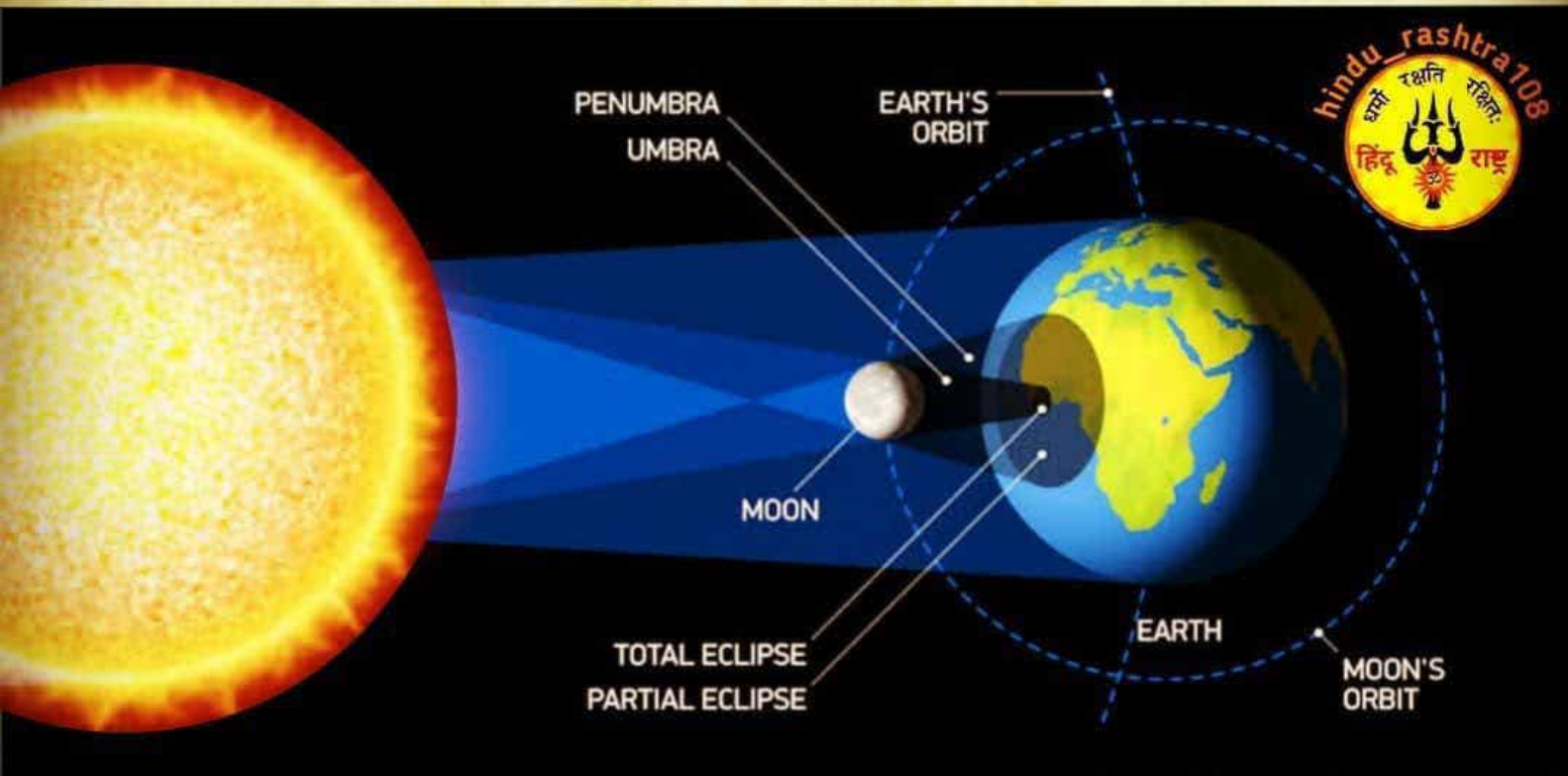

## Meaning:

Moon is of water, sun is of fire, earth is of soil, and its shadow is of darkness

The moon covers the sun and the great shadow of the earth covers moon

**Did You Know?**

**Sleeping with legs towards south is not considered as good position for sleeping in Hinduism**

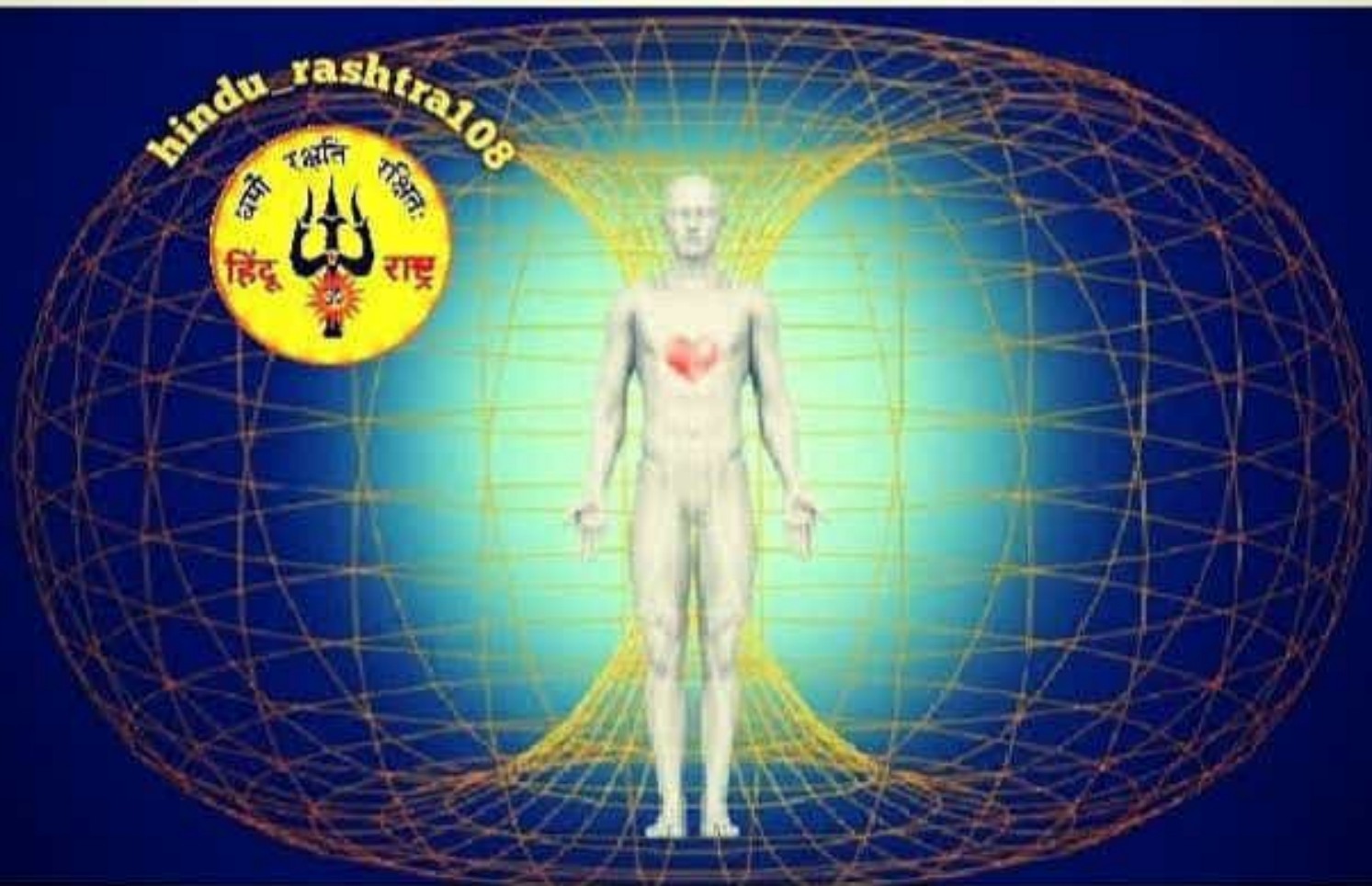

**Why?**

**Swipe To See** 🖱️

**It is because the human body has its own magnetic field (due to the flow of blood) and Earth is a giant magnet. When we sleep with head towards north, our body's magnetic field become completely asymmetrical to the Earth's Magnetic field which cause problems related to blood pressure and our heart needs to work harder in order to overcome this asymmetry of Magnetic fields.**

**Also our body have the significant amount of iron in our blood. When we sleep in this position, iron from the whole body starts to congregate in the brain which can cause a headache, Cognitive Decline and brain degeneration.**

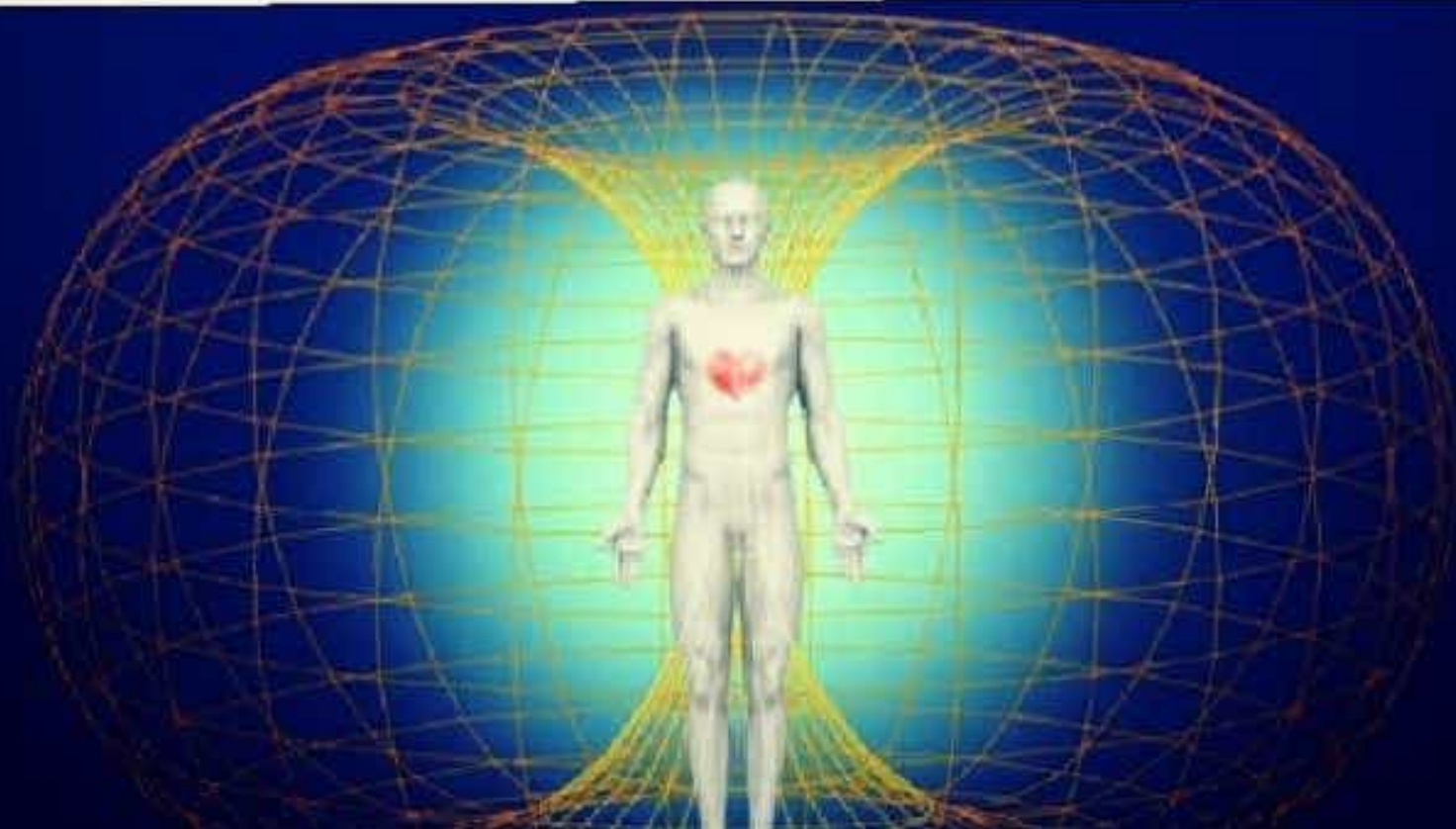



# Did You Know? Yug Cycle

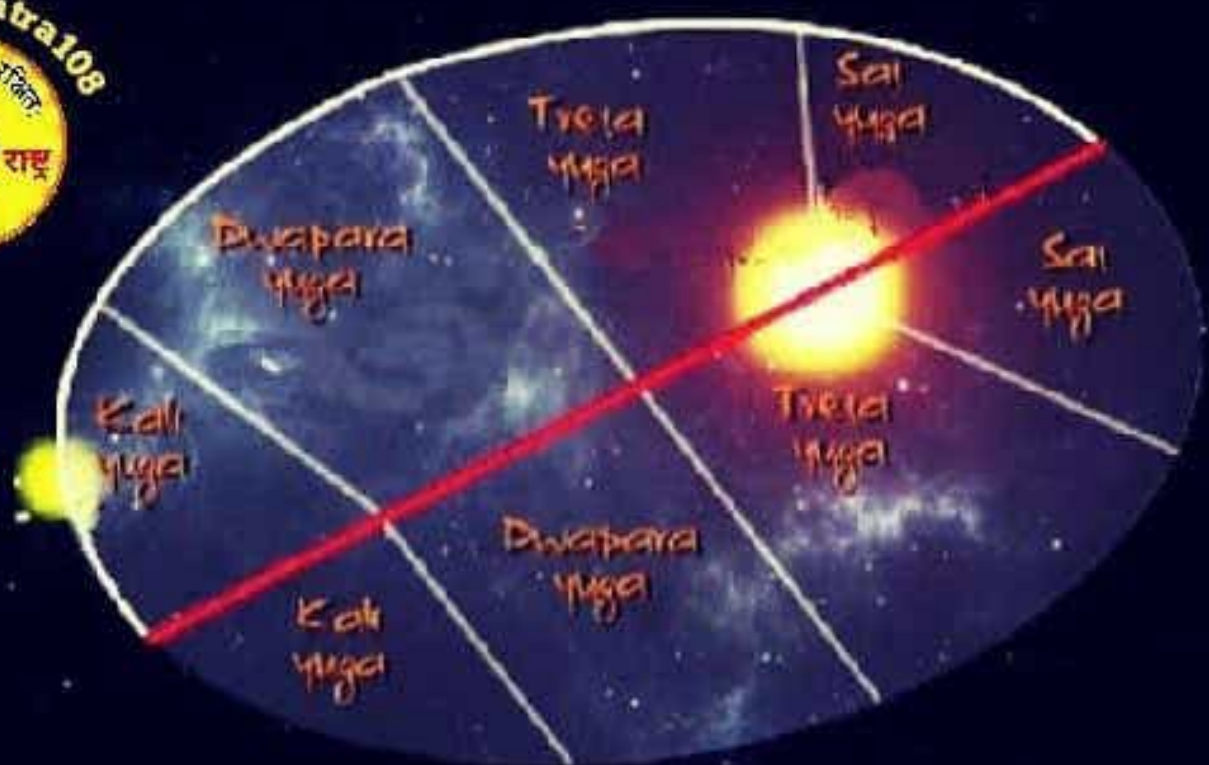

**We calculate the age of the earth from the age of Brahma. The Vedic chronology of Hinduism uses a base unit of calculation called a chaturyugi. This is comprised of 4 yugas (periods of time).**

**1,728,000 years = sat yuga**  
**1,296,000 = treta yuga**  
**864,000 = dwapar yuga**  
**432,000 = kali yuga**



**4,320,000 years = one chaturyugi (one 4-yuga cycle)**  
**1000 chaturyugis = one day of Brahma**  
**1000 chaturyugis = one night of Brahma**  
**8,640,000,000 years = one full day (24 hours) of Brahma**  
**100 celestial years = age that Brahma lives to**  
**50 celestial years = Brahma's**  
**We have passed 27 Mahayugas till now. The current age is**  
**155.5 trillion years**

# Electric battery used in Ancient India around 4000 years ago

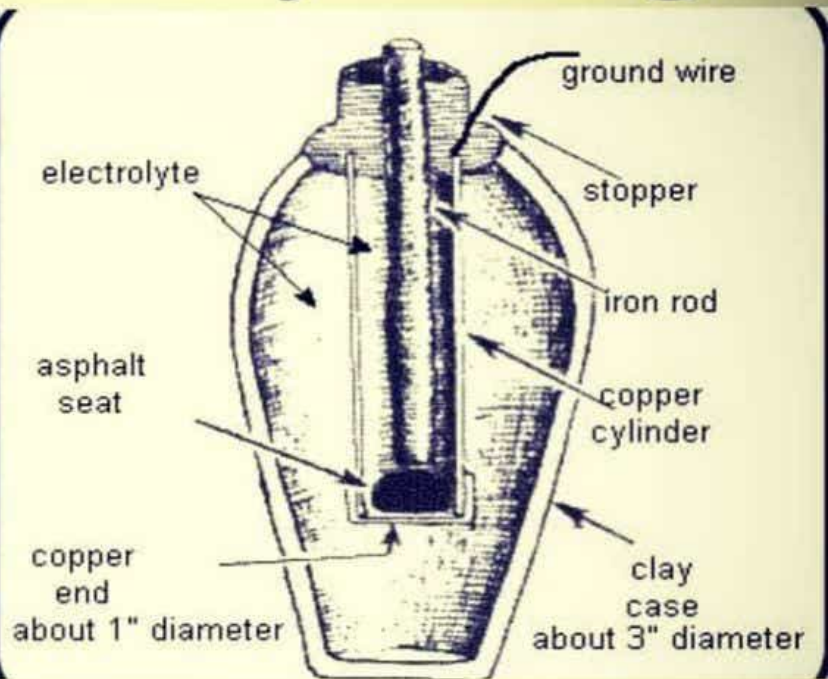

Remember, we read in history books that the electric battery was created by a man called Alessandro Volta just 200 years ago, but sage Agastya used this battery at least 4000 years ago. But what's really strange is that Alessandro Volta uses pretty much the same materials for creating the "veryfirst battery".

# Ancient Binary System



$$f_{a,\sigma^2}(\xi_1) = \frac{(\xi_1 - a)}{\sigma^2} f$$

$$\frac{\partial}{\partial \theta} f(x, \theta) dx = M(T(\xi))$$

MATHEMATICS

**Mathematician Gottfried Leibniz demonstrated the advantages of the binary system for computations.**

**However, Leibniz was by no means the first person to discover the binary code. His invention was merely a re-invention based on ancient knowledge.**

**There is evidence that people in ancient India were familiar with the binary code thousands of years ago.**

**Having those discoveries in mind, scientists now questions the origin of the binary system and the date of its invention.**

**The Indian scholar **Pingala** (c. 2nd century BC) developed a binary system for describing prosody. He used binary numbers in the form of short and long syllables, making it similar to Morse code. They were known as **laghu** (light) and **guru** (heavy) syllables.**

# 2000+ years old Acharya Charaka states in the Sutrasthana of the Charaka Samhita:

**"A potent poison also becomes the best drug on proper administration. On the contrary, even the best drug becomes a potent poison if used badly".**

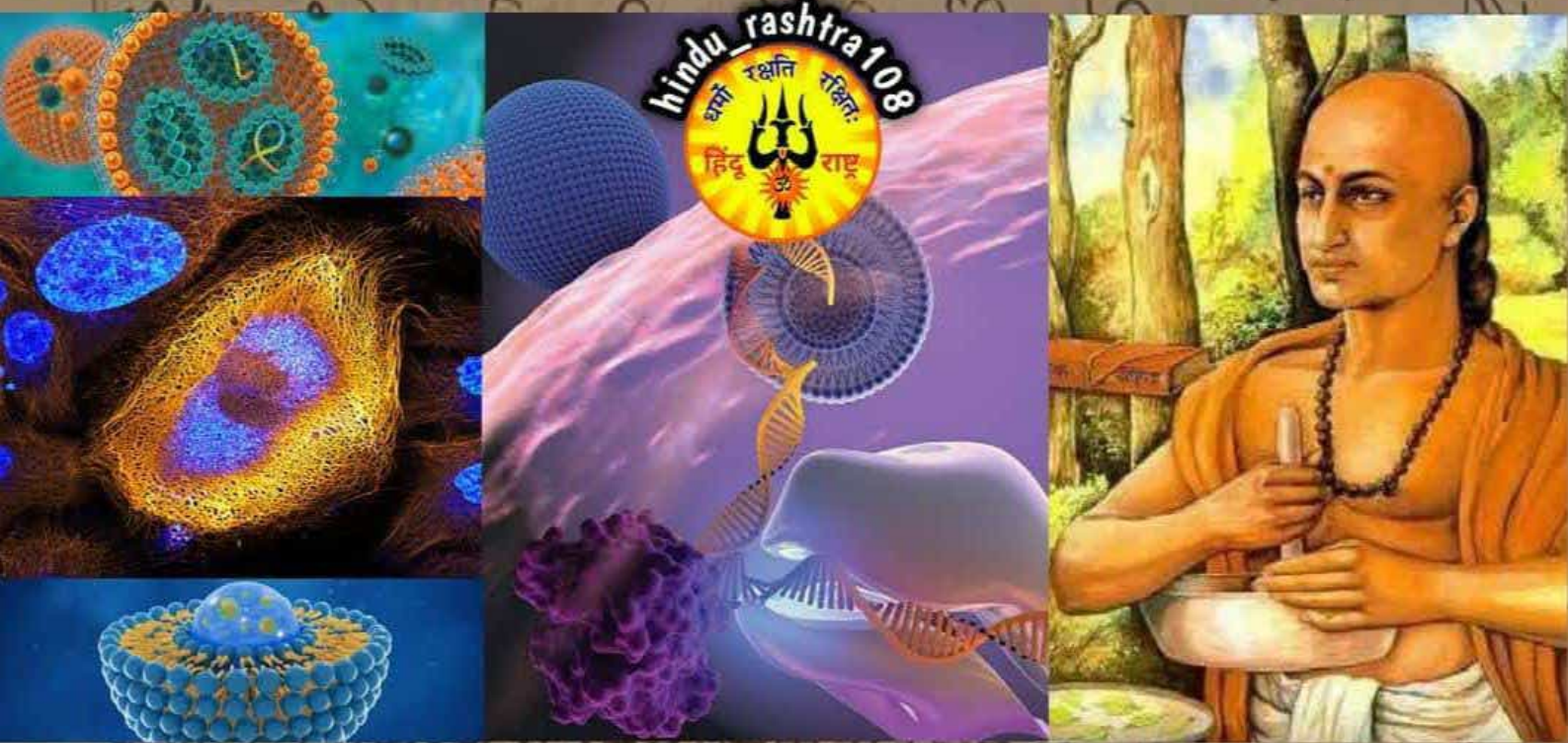

**1000s of yrs before West knew about medicine, "Charaka Samhita" described medicinal qualities & functions of 100,000 herbal plants.**

# RAINBOW & LENS



## Shloka:

Aprapyagrahanam

kayabhrapatalasphatikantaritopalabdheh ||

Source: Nyaya darsanam Adhayayah 3, Sutram 46, Kanadah (800 BCE)

## Meaning:

That which cannot be perceived (with naked eye) can be perceived with lens made of glass, mica or crystal

## Shloka:

Suryasya vividhavarnah pavanena Vighaitah karah sabhre |  
Viyati dhanuh samsthanah ye drsyante tadindradhanuh ||

Source: Brhat Samhita, Shloka 35, Varahamihirah (6th Century AD)

## Meaning:

The multi coloured rays of the sun being dispersed by the wind in a cloudy sky are seen in the form of a bow which is rainbow

# MAGNETS

## Shloka:

Bhramakam cumbakam caiva karsakam dravakam तथा |  
Evam caturvidham kantam romakantam ca pancamam |  
Ekadvitricatuhpancasarvatomukhameva tat |  
Pitam krsnam तथा raktam trivarnam syat prthak prthak

Source: Rasarnavam, Patalah 6, Adhyayah 40, shloka 21 (12th century AD)

## Meaning:

Magnets are of 5 varieties- Bhramakam, Chumbakam, Karshakam, Dravakam and Romakantam. They again are single faced, double faced, three faced, four face, five faced and multi faced. Each is again in three colors i.e yellow, black or red





# FLASH OF LIGHT

Speed  
 $3 \times 10^8$   
m/s

1 Juug = 12000

1 Sahastra = 1000

1 Yojan = 8 Miles

Thus

$12000 \times 1000 \times 8 = 96,000,000$  miles

1 mile = 1.6 kms

$96,000,000 * 1.6 \text{ kms} = 153,600,000$  Kms

**Shloka:**

Tatha ca smaryate yojananam sahasre dve dve sate dve ca  
yojane ekena nimishardhena kramaman.

Source: Sayanacarya's commentary (14th Century AD)

**Meaning:**

It is remembered (that) salutation to Thee(sun), the traveler of 2,202  
yojanas in half a nimisha



# SCIENCE BEHIND THE CHANTING OF AUM

ओ३म् (ॐ)

TEMPLE  
SCIENCE



AUM

**HUMAN BEINGS ARE CAPABLE OF. ONLY THREE  
SOUNDS ARE EXIST IN THE SYSTEM NATURALLY  
OTHER SOUNDS ARE ONLY MIXTURE OF THESE  
THREE SOUNDS**

**THESE THREE SOUNDS CAPABLE OF  
TOUCHING ALL THE 72000 NADIS IN THE  
BODY**

**THESE ARE ONLY THREE WORDS YOU  
CAN UTTER EVEN IF YOU REMOVE UR  
TOUNGUE**

# Did You Know?

## There are 108 Divya Desam



**A Divya Desam or Vaishnava Divya Desam is one of the 108 Vishnu temples that are mentioned in the works of the Alvars (saints). "Divya" means "divine" and "Desam" means temple. Of the 108 temples, 105 are in India, one is in Nepal, and last two are outside the Earthly realms.**

**Did You Know?**

**At sunrise water is offered to Sun**



**Why?**

**Swipe To See**

विज्ञान के अनुसार सूर्योदय के समय सूर्य की किरणें ज्यादा तेज नहीं होती है जो शरीर के लिए एक औषधि का काम करती हैं। उगते सूर्य को जल चढाने से तथा जल की धार में से सूर्य को देखने से सूर्य की किरणें जल में से छन कर हमारी आँखों तथा शरीर पर पड़ती हैं। जिससे आँखों की रौशनी तेज होती है तथा पीलिया, क्षय रोग, तथा दिल की बीमारियों का खतरा कम होता है। सूर्य की किरणों से विटामिन-डी भी प्राप्त होता है इसके अलावा सुबह सुबह सूर्य को जल चढाने से शुद्ध ऑक्सीजन भी हमें मिलती है।

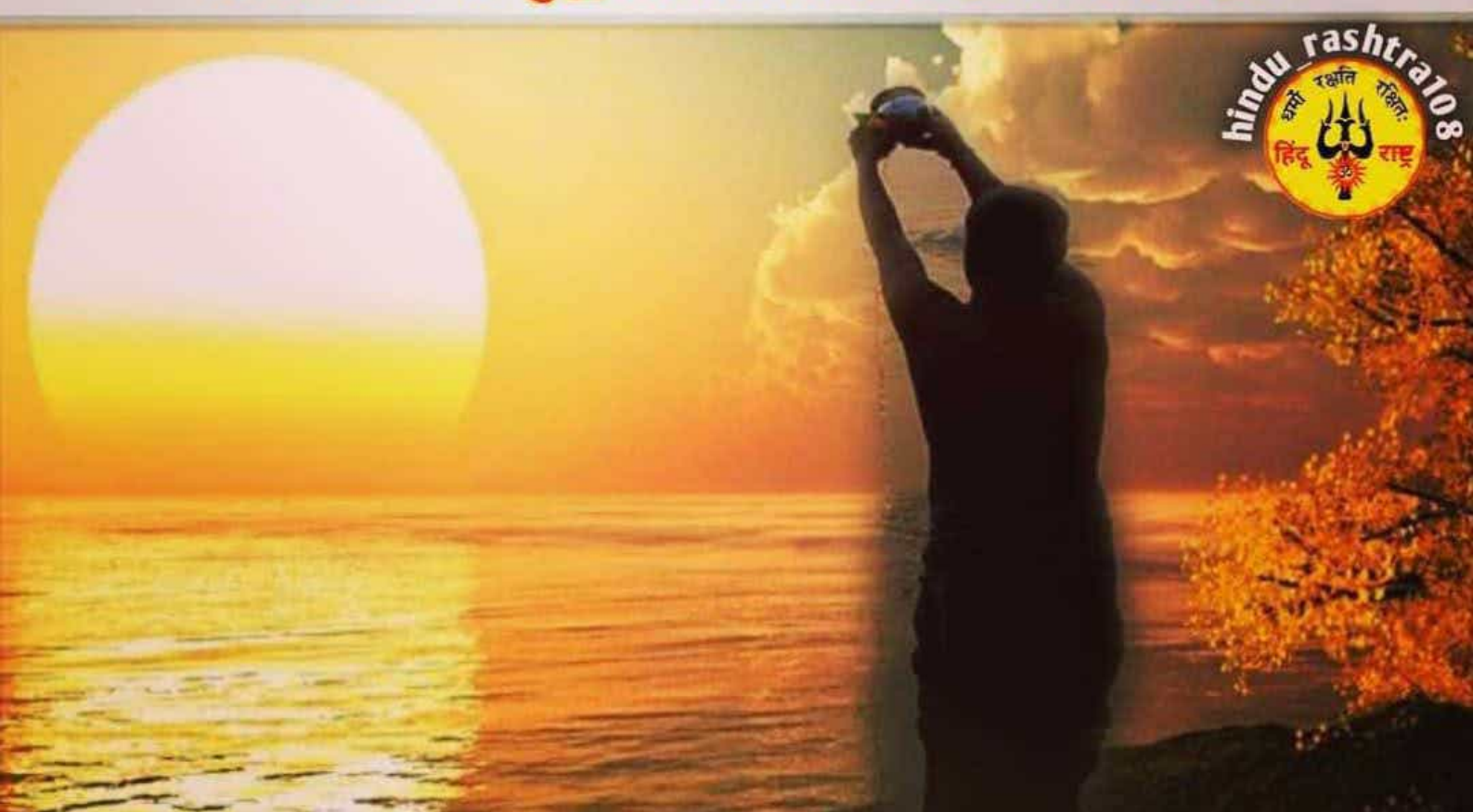

**Did You Know?**

**Leaves of Tulsi plant should not be chewed**



**Why?**

**Swipe To See** 🖱️

**Although Tulsi leaves are very helpful for many diseases. Tulsi leaves contain a high amount of mercury and iron, which are released on chewing them. These minerals are known to damage your teeth and cause discoloration. Moreover, Tulsi leaves are also slightly acidic in nature and since the environment in our mouth is alkaline, it may cause the tooth enamel. So we should not chew rather swallow.**



## Bhagavata Purana says -

There are innumerable universes and although they are unlimitedly large, they move about like atoms in You. Therefore You are called unlimited. Because You are unlimited, neither the lords of heaven nor even You Yourself can ever reach the end of Your glories. The countless universes, each enveloped in its shell, are compelled by the wheel of time to wander within You. At last all possibilities become successful by revealing You as their final conclusion. (Bhagavata Purana 10.87.41)

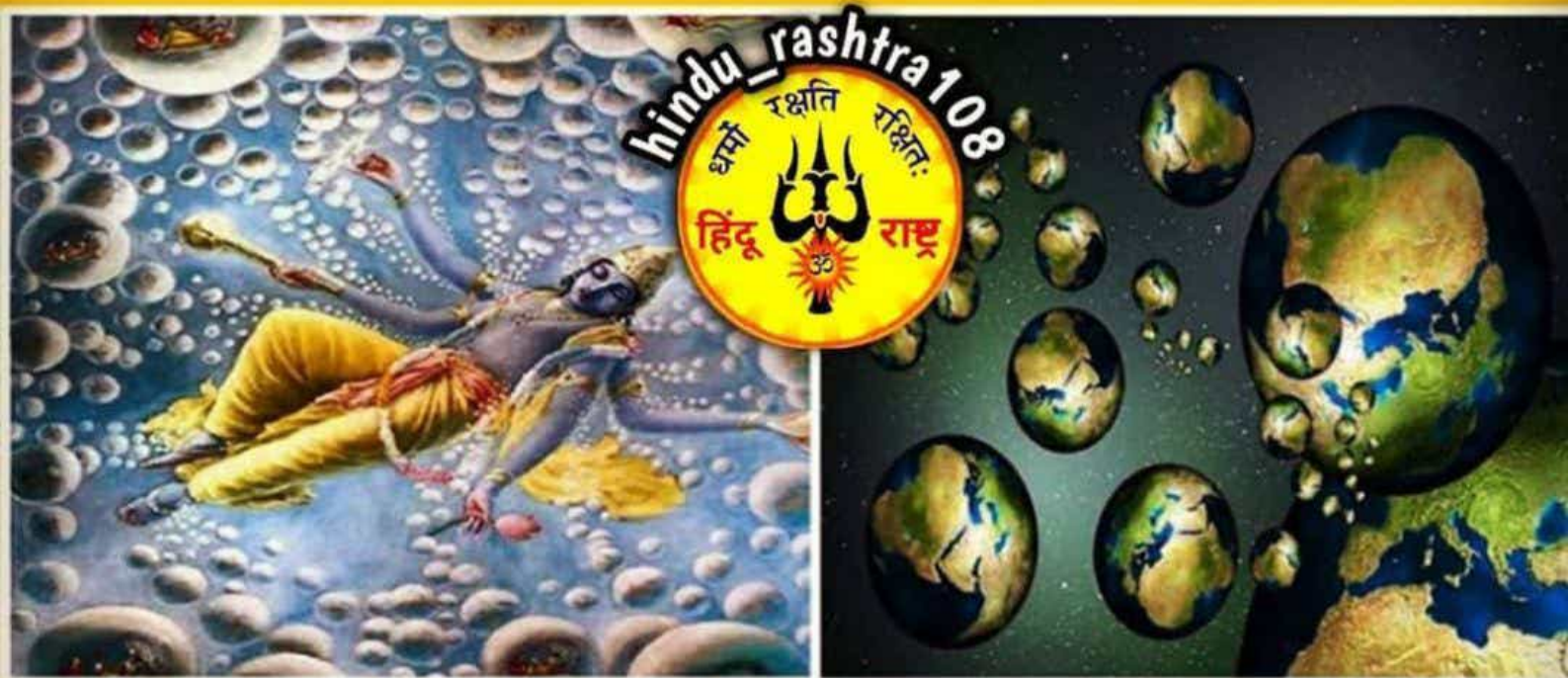

*Quantum Mechanics says every system exists in a superposition of infinite possibilities .Copenhagen interpretation suggested that when we observe the superposition breaks down and the system chooses the best possible result. But later on the Multiverse concept suggested that after the breakdown of superposition all possibilities occurs in infinite alternate universes or in multiverse.*

## Bhagavata Purana says -

There are innumerable universes and although they are unlimitedly large, they move about like atoms in You. Therefore You are called unlimited. Because You are unlimited, neither the lords of heaven nor even You Yourself can ever reach the end of Your glories. The countless universes, each enveloped in its shell, are compelled by the wheel of time to wander within You. At last all possibilities become successful by revealing You as their final conclusion. (Bhagavata Purana 10.87.41)



*Quantum Mechanics says every system exists in a superposition of infinite possibilities .Copenhagen interpretation suggested that when we observe the superposition breaks down and the system chooses the best possible result. But later on the Multiverse concept suggested that after the breakdown of superposition all possibilities occurs in infinite alternate universes or in multiverse.*



- 1) In the year 1781, the solar system and nine planets were discovered, but long before that the NAVAGRAHA had been described in the 5000 year old Rig Veda.
- 2) Copernicus gave Heliocentric Theory in 15th century. But much prior to that the NAVAGRAHA pooja and Konark Sun temple were based on Heliocentric Theory.

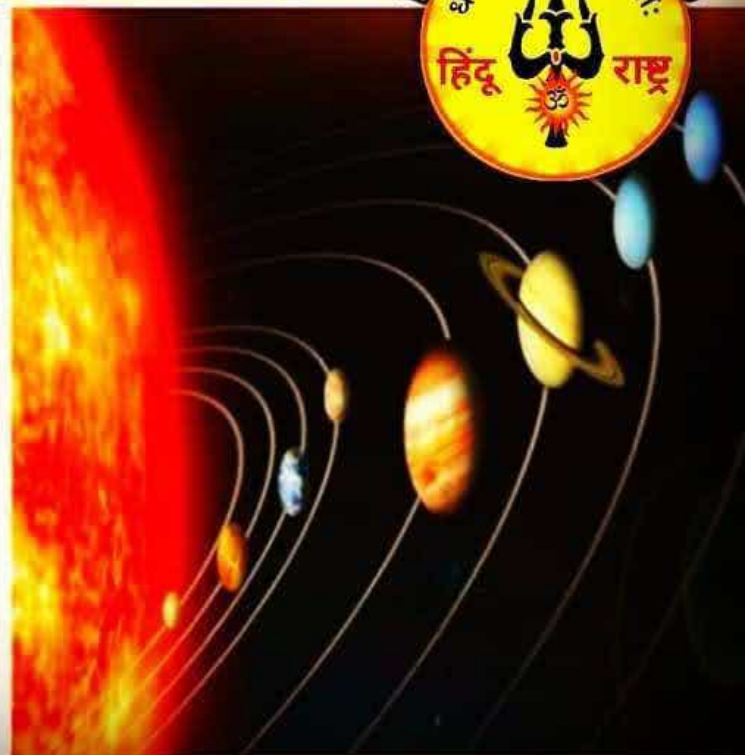

***Did you know you can cure various 'incurable' diseases with only your hands ?***

## Hand Reflexology Chart

right palm

left palm

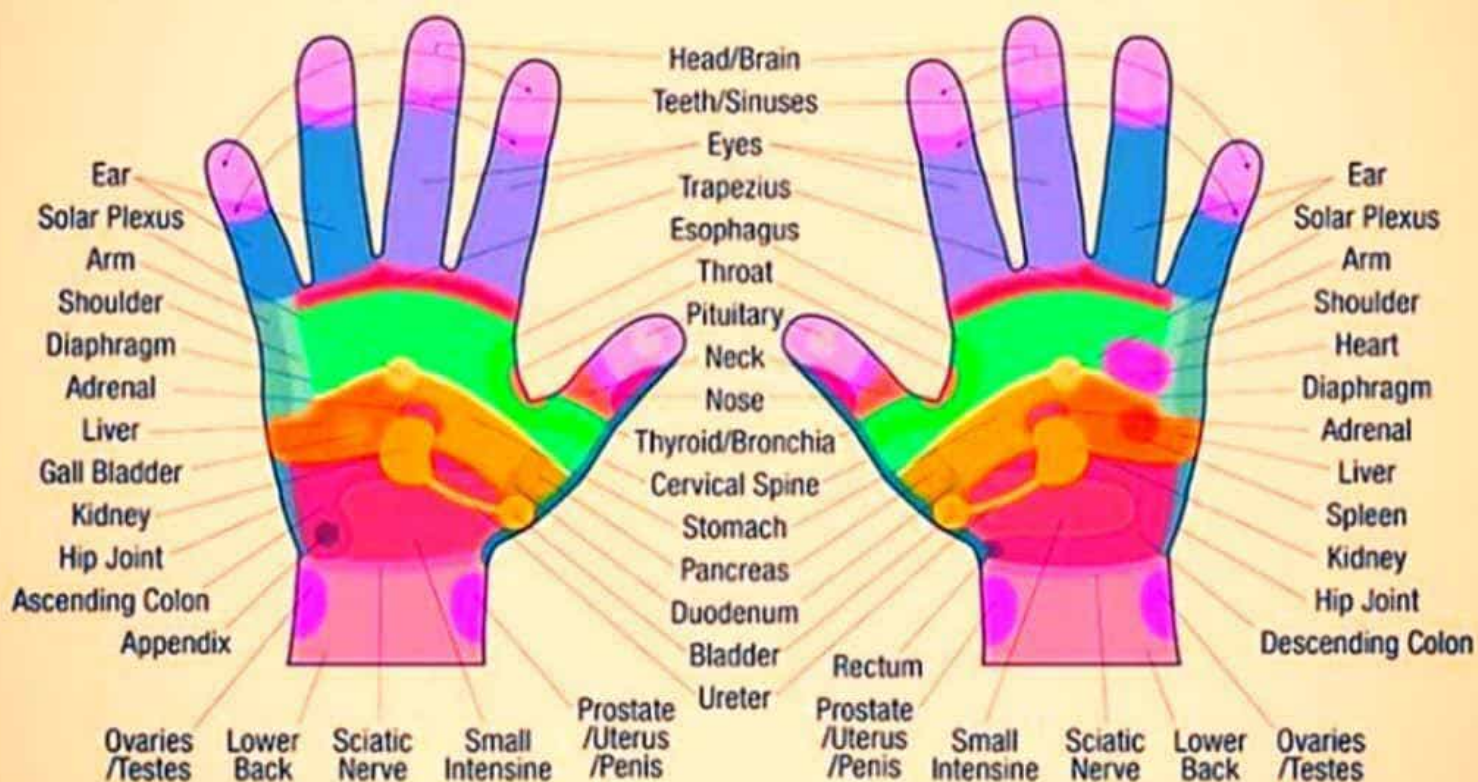

**@hindu\_rashtra108**

There is an Ancient Indian technique called as "Mudra" whereby one puts their hands into certain gestures. Based on one's illness to cure diseases

# Hindus do prayer before eating food



भोजन लक्षण



ब्रह्मार्पणं ब्रह्महविर्ब्रह्माग्नौ ब्रह्मणा हुतम्।

ब्रह्मैव तेन गन्तव्यं ब्रह्मकर्म समाधिना ॥

ॐ सहनाववतुसहनौ भुनक्तु।

सहवीर्यं करवावहैतेजस्विनावधीतमस्तुमा विद्विषा वहै ॥

ॐ शान्तिः शान्तिः शान्तिः ॥

**Subtle-effects of eating without praying and without talking (silently)**

(To understand the subtle-process, read points sequentially - 1, 1A, 1B, 1C, 1D, 1E, 2, 2A, 2B, 2C, 3, 4, 5, 5A, 5B, 5C, 5D, 6)

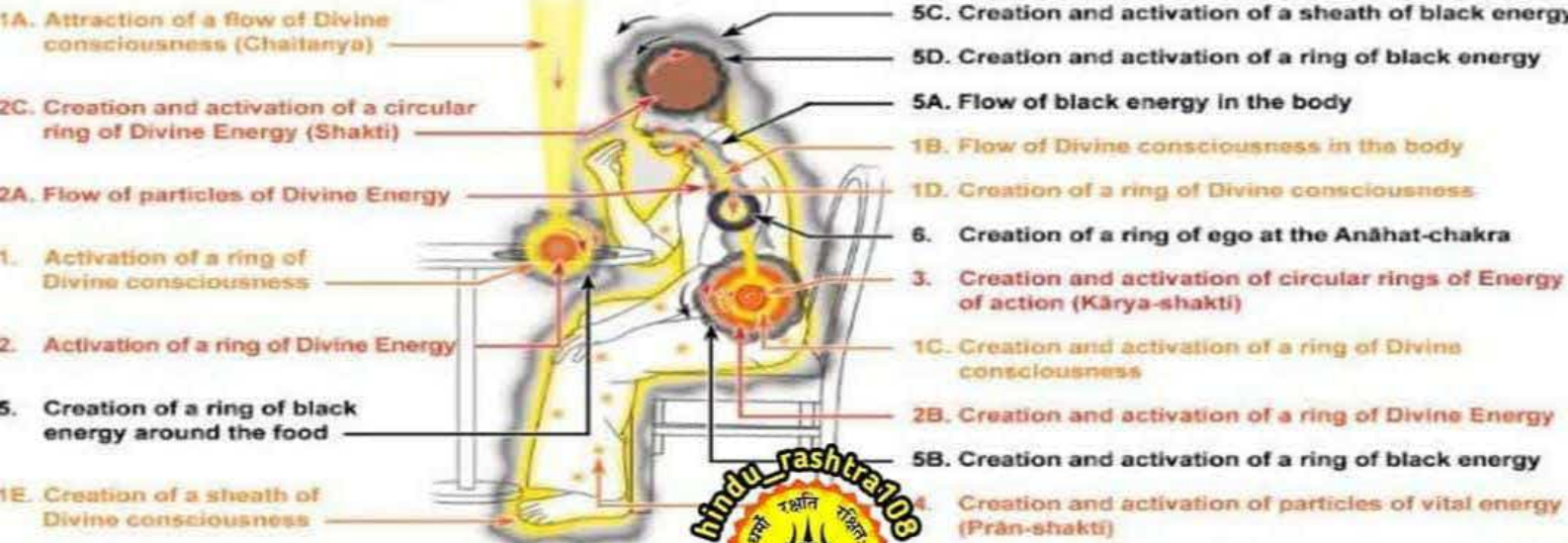

Picture on subtle-knowledge by Ananda Vajra, Europe, SSRF

© All Rights Reserved

**It is because Hindus thank Bhagwan for the food. The other reason is to activate digestive enzymes for the better digestion and activate vital energy and divine consciousness.**

# Scientists capture clearest ever photo of the Sun - and it looks just like honeycomb

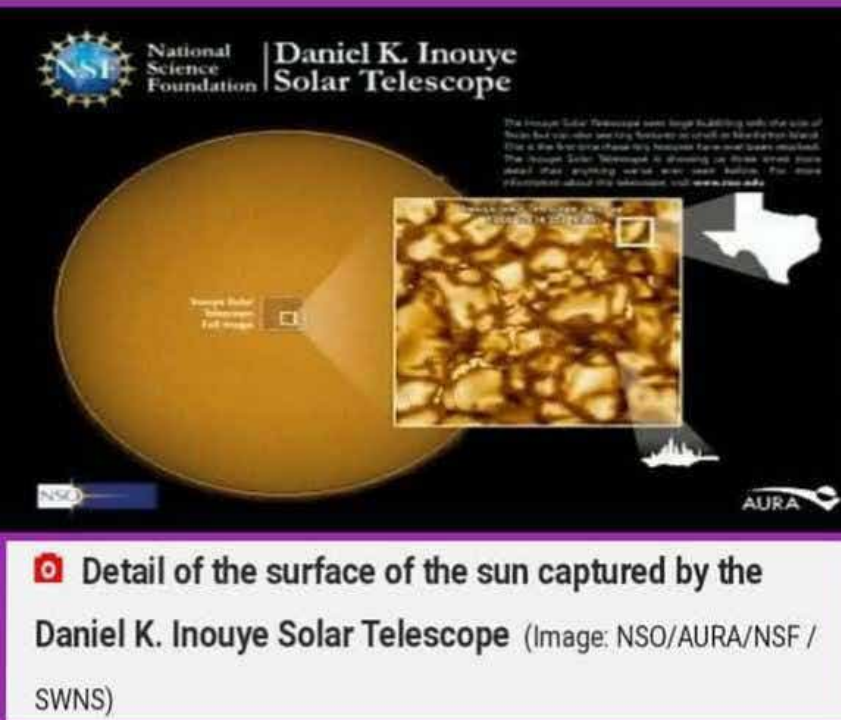

Detail of the surface of the sun captured by the Daniel K. Inouye Solar Telescope (Image: NSO/AURA/NSF / SWNS)



The surface of the sun (Image: NSO/AURA/NSF / SWNS)

असौ वा आदित्यो देवमधु तस्य द्यौरेव  
तिरश्चीनवंशोऽन्तरिक्षमपूपो मरीचयः पुत्राः ॥

~ छान्दोग्योपनिषद् (Chandogya Upanishad) ॥ ३.१.१ ॥

The Sun is described as the honeycomb laden with glowing light of honey in the Chandogya Upanishad back in 8 B.C.E.

And now Daniel K Inouye solar telescope proves that the surface of Sun is like a Honeycomb and the surface colour is Aurus (Golden).

## Did You Know?

People who are visiting the temple should Ring the bell before entering the inner sanctum (where the main idol is placed).



**Why?**

**Swipe To See** 

**This neuroscientist has coined the term “The Sanskrit effect.” He writes that memorising Vedic mantras increases the size of brain regions associated with cognitive function such as memory (both short-term and long-term).**

**The brains of all the 42 participants were examined using the method called structural magnetic resonance, with the magnetic resonance. This method allows the study of the size and shape of individual parts of brain. The so called grey matter (GM) of the brain is a region full of neuronal cells.**

**The Indo-Italian team analysed the brain regions of the 21 Pandits and 21 control volunteers and found some remarkable differences between the two. They found the grey matter in Pandits to be denser and the cortex thicker than in ‘controls’.**

**|| the इंसक्रिट एफिक्ट ||**

**DO YOU THINK YOUR HINDU SCIENTISTS WERE IGNORANT?**

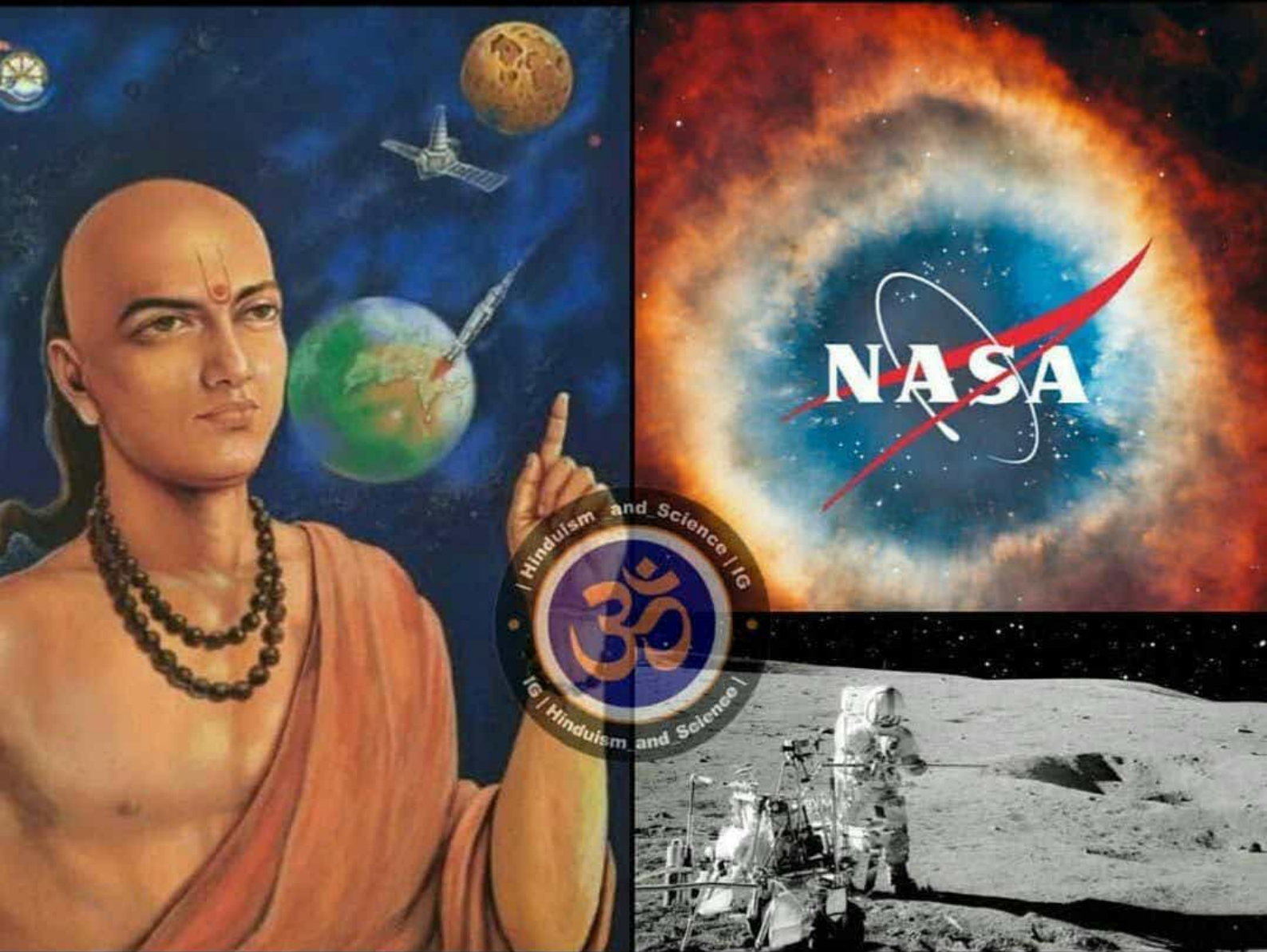

**Aryabhata Gave a List of the Orbital Periods [Days] Of Various Planets In Our Solar System. Compare With NASA List Today**

**LET'S MAKE IT VIRAL** 

4500 years ago, Aryabhata gave a list of the Orbital Periods [days] of various planets in our solar system. Compare with NASA list today.

Mean sidereal periods compared with those given in Herschel's

Astronomy : - -

**Aryabhata**

	Aryabhata		NASA
	<i>From Surya Siddhanta</i>	<i>From Herschel's Astronomy</i>	
	Mean Sidereal Periods in mean Solar days.	Mean Sidereal Periods in mean Solar days.	
The Earth ... ..	365·25875	365·2563612	<b>365.2</b>
The Moon ... ..	27·32167	27·32166148	<b>27.3</b>
The Moon's Nodes...	6794·443	6793·39108	
The Moon's Apogee	3231·2	3232·575343	
Mercury ... ..	87·9697	87·96925	<b>88.0</b>
Venus ... ..	224·69792	224·7007869	<b>224.7</b>
Mars ... ..	686·9975	686·9796458	<b>687.0</b>
Jupiter ... ..	4332·3206	4332·5849212	<b>4331</b>
Saturn ... ..	10765·773	10759·2198174	<b>10747</b>



# Formula for Area of a Triangle as per Yajur Vedam

दीर्घचतुरश्रस्याक्षणया रज्जुः पार्श्वमानी तिर्यग्  
मानी च यत् पृथग् भूते कुरुतस्तदुभयं करोति॥

- Baudhāyana Sulba Sūtra, Yajur Vedam

*"A rope stretched along the length of the diagonal produces an area which the vertical and horizontal sides make together"*

$$C^2 = A^2 + B^2$$

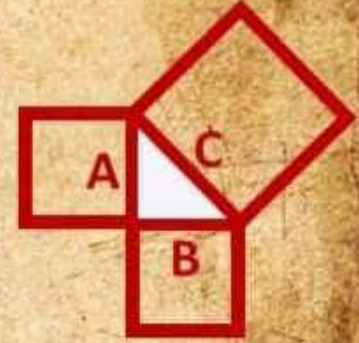

This is Baudhayana Sulba Sutra in Yajur Vedam, defining how to calculate **Area of a Triangle**. In today's world this is called Pythagoras Theorem given by Pythagoras in 500BCE but this method is widely popular in India since thousands of years and is as is **as old as Yajur Vedam** itself.

This formula is used in constructing Yagna Vedi in the shape of an Eagle with TRIANGULAR TILES in a special type of Yagna called AGNICAYANA.



Process of building Agnicayana Vedi and using Triangular Tiles



PROJECT  
**SHIVO HAM**

**In Pancha Siddhantika, Varahamihira estimated diameters of the planets, like Mercury, Venus, Mars, Saturn and Jupiter.**

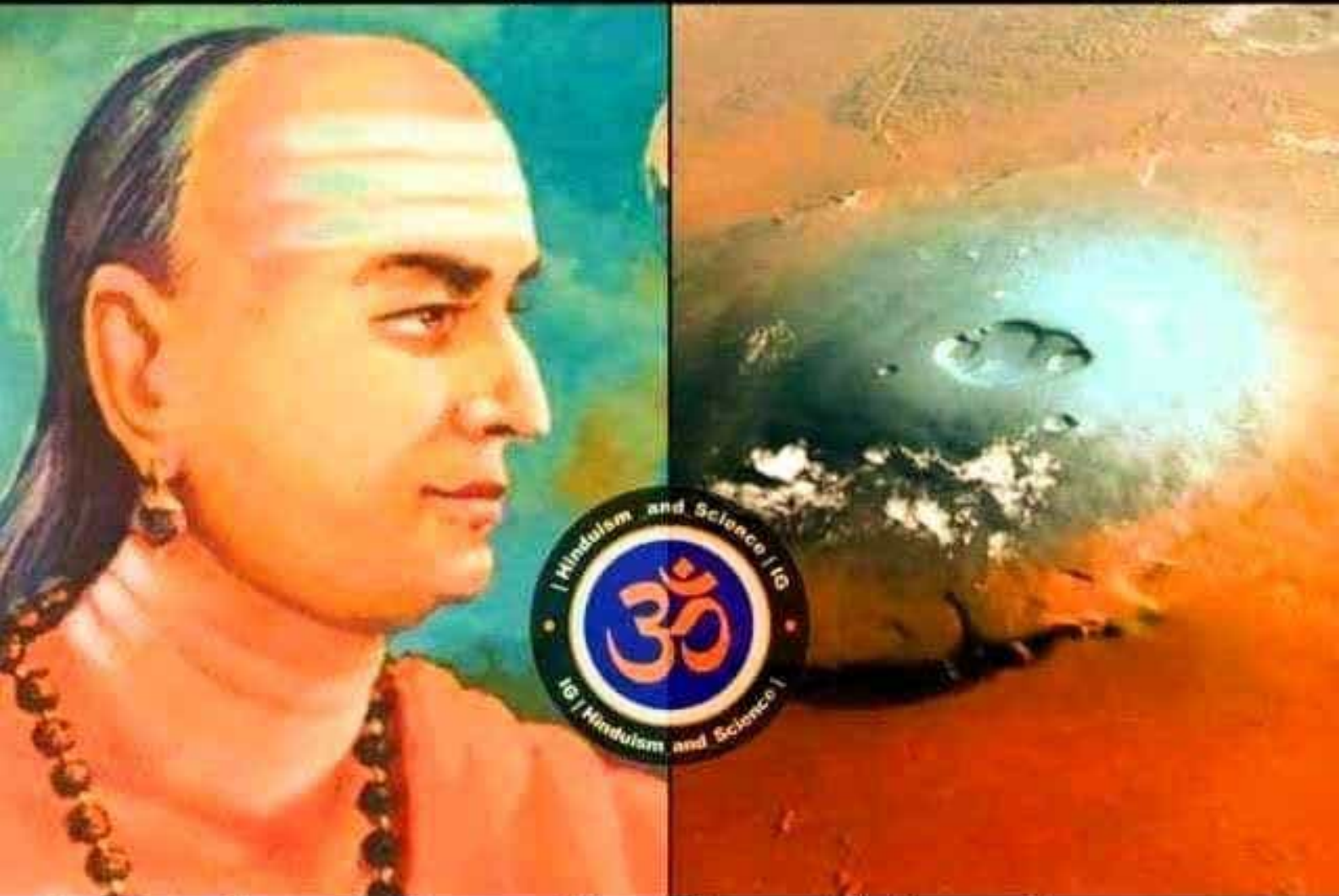

**Apart from these Varahamihira also wrote about the presence of water on Mars (Chapter XVIII). This book had a detailed description of planet Mars. He also wrote in his book that planet Mars has both water and iron present on its surface, which have now been revealed by NASA and ISRO.**

# Did you know ?

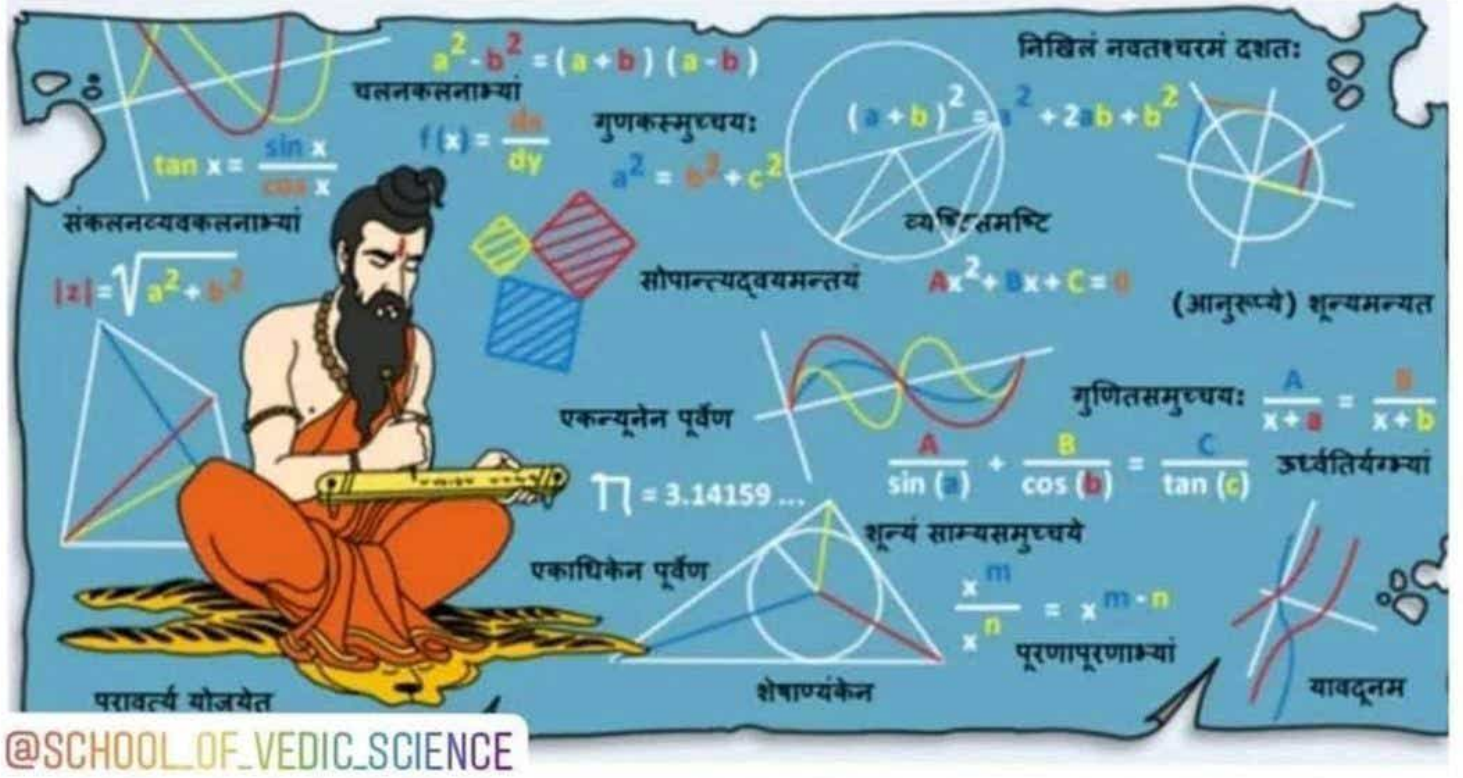

The word Geometry is emerged from the Sanskrit word gyaa-miti which means "measuring the Earth". And the word Trigonometry is similar to tri-kona-miti meaning "measuring triangular forms". Euclid is credited with the invention of Geometry in 300 BCE while the concept of Geometry in India emerged in 1000 BCE many years before than Europe

# SPACESHIP MENTIONED IN RIG VEDA



35  
 वो देवेषु नवद्युताग्निः। तनू रूद्रो धिप्रमतिश्च कारवे त्वे कल्याणवसु विश्वमे विषेत्  
 मग्ने प्रमतिस्त्वपितासि न स्ववयस्त्वं तव नाम यो वयो। स त्वारायः भ्रानि नः संसहस्विणः  
 सुवीर्यं यति प्रतपाम दापय ॥३३॥ त्वामग्ने प्रथममायुमायवे देवा अकृण्वन्त दुषस्य वि  
 श्वपति। इत्थामकृण्वन्मनुषस्य शासनी पितृयेषु त्राममैकस्य जायते त्वं नो अग्ने नवदेव  
 पाकसि मघो नो रक्षत च श्ववेद्य। गतातो केस्य ते न युग वामे स्य निमेषं रक्षमाणस्तव  
 ते त्वमग्ने यज्ये पाक रतेरो निषे गाय चतुरक्ष इध्यसे। यो रान हव्या वं काय धायसे की  
 रे श्विन्मंत्रे मनसा वनोषितं त्वमग्ने उरुशांसा यवा घने स्या ह्ये देवणाः परमं वनोषित  
 त्। आध्रस्य चित्रमतिरुच्यसे पिता प्रपाकं शास्ति प्रदिशो विदुर्घरः। त्वमग्ने प्रयत दक्षि

वामदेवः गौतमः

छन्दः जगती 1-8, त्रिष्टुप् 9

देव

अनुश्वो जाता अनभीशुरुक्थ्योर् रथस्त्रिचक्रः परि वर्तते रजः ।  
 महत्तद्वो देव्यस्य प्रवाचनं द्यामृभवः पृथिवीं यञ्च पुष्यथ ॥ 1 ॥  
 रथं चे चक्रुः सुवृत्तं सुचेतसोऽविह्वरन्तं मनसस्परि ध्याया ।  
 तां ऊ न्वरस्य सर्वनस्य पीतयु आ वो वाजा ऋभवो वेदयामसि ॥ 2 ॥

# TELEPORTATION IN HINDUISM

THE HINDU SAGE NARADA HAD THE  
POWER OF TELEPORTATION

THE REST OF THE HINDU GODS HAD THE  
SAME POWER



TELEPORTATION MEANS TRAVELLING  
ANYWHERE IN THE UNIVERSE WITHIN  
FRACTION OF SECONDS.

ANCIENT INDIANS WERE MORE  
ADVANCED THAN WE THINK

# Did you know ?

$$1^2 + 2^2 + \dots + n^2 = \frac{n(n+1)(2n+1)}{6}$$

$$1^3 + 2^3 + \dots + n^3 = \frac{(1+2+\dots+n)^2}{4}$$

$$1^2 + 2^2 + \dots + n^2 = \frac{n(n+1)(2n+1)}{6}$$

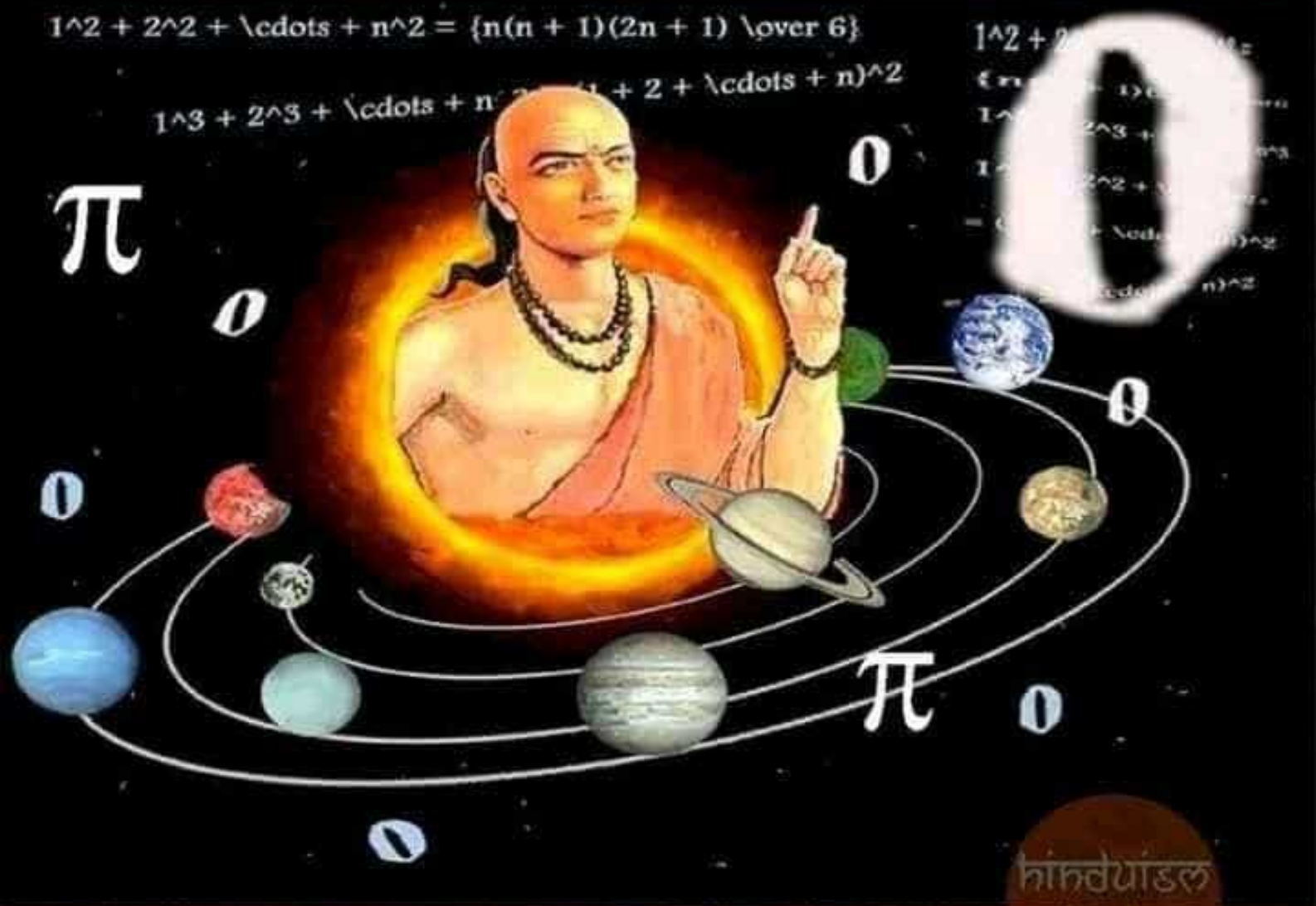

হিন্দুগণ্ডল  
facts

Aryabhata, a Hindu scientist-mathematician gave the concepts regarding zero, pi, trigonometry, motions of the Solar system and eclipses .

# Electric Battery In Agastya Samhita



@sanatanDharma

Not Benjamin Franklin but  
Rishi Agastya has gifted the  
world the basic method of  
Generating Electricity

Read Caption

# Ujjain Mahakaleshwar

The Powerhouse of Time Computation



Ujjain Mahakaleshwar temple is the intersection point of Tropic of Cancer & 0° Meridian & was the central point of measuring date, day & time in Ancient India & was the hub of Astronomy.

उदयो यो लङ्कायां सोऽस्तमयः सवितुरेव सिद्धपुरे |  
मध्याह्नो यमकोट्यां रोमकविषयेऽर्धरात्रः सः ॥ २३ ॥

- 13<sup>th</sup> Slokam , 15<sup>th</sup> Chapter, Pancha Sidhantika

In Pancha Sidhantika, Varahamihira – one of the greatest Indian Astronomers of 5<sup>th</sup> Century writes  
*“When it is Sunrise in Lanka (another name for Ujjain), it is Sunset in Siddhapura, Noon in Yamakoti, & Midnight in Romaka.”*

This verse was written ~1500 years ago & these cities names are not traceable today. Going by the day & night cycle , which never changes, they are shown indicatively below.



PROJECT  
SHIVOHAM



**Bhoja Prabandhan is an 11th century Ancient Indian Book which describes information about Brain Surgery. It was written by 2 Brahmin brother's from the school of Ujjain, who were hired to cure King Bhoja who was afflicted by a tumor in his brain.**



**After successful brain surgery, Brahmin brother's wrote this book. They artificially induced a coma with a special preparation known as the Sammohini (anesthesia) and then opened king's skull to remove the tumor. King was then brought back to consciousness with another drug!!**

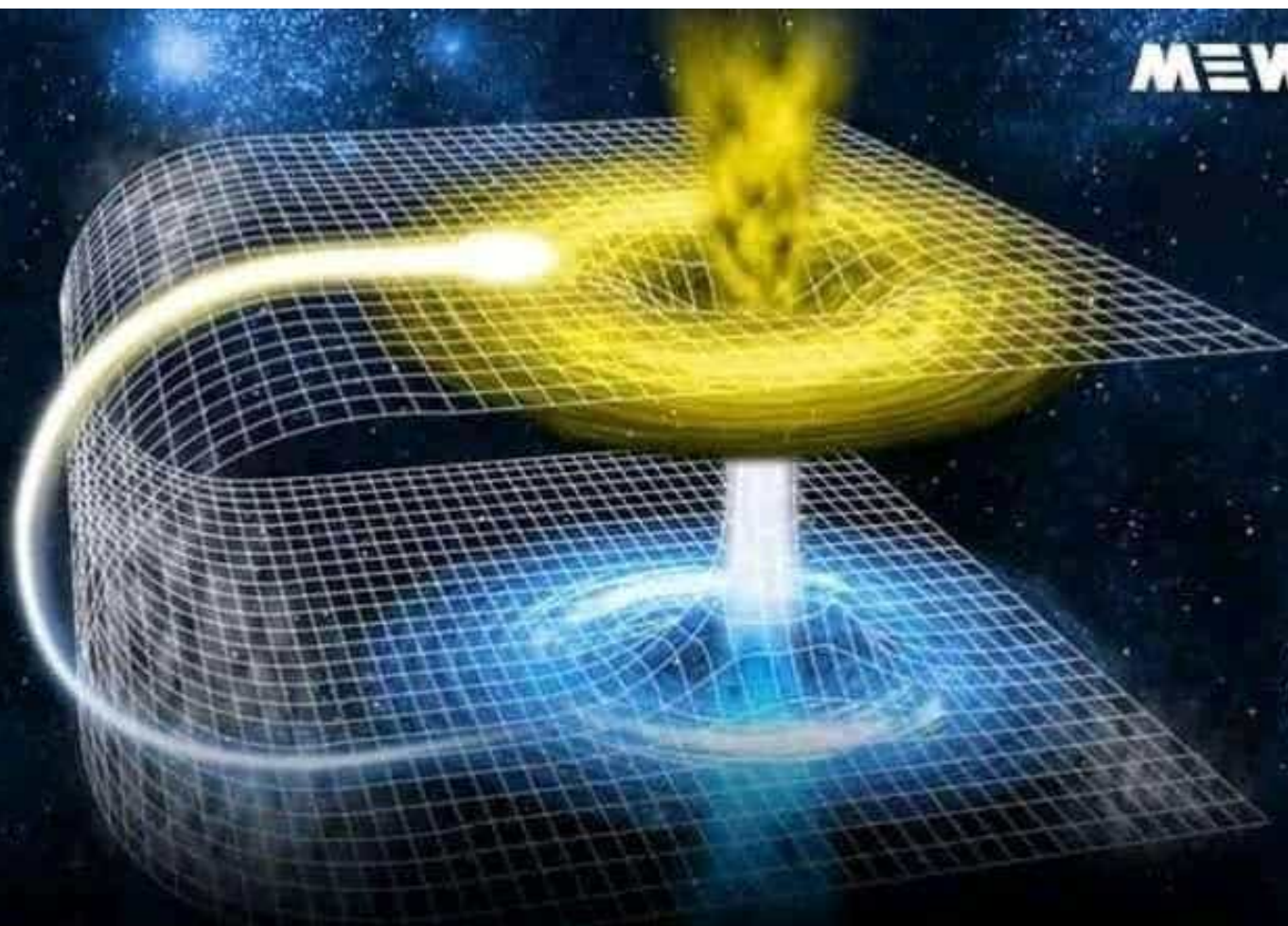

Our materialistic **World** is **3 dimensional**. First Dimension is **UP and Down**, Second is **Left and Right** and the third one is **forwards and Backwards**. Our TV is 2 dimensional in which anything can go only **UP, Down and Left , Right** . But we live in **3D World** in which we can go **UP-Down, Left-Right and Forwards- Backwards** too.

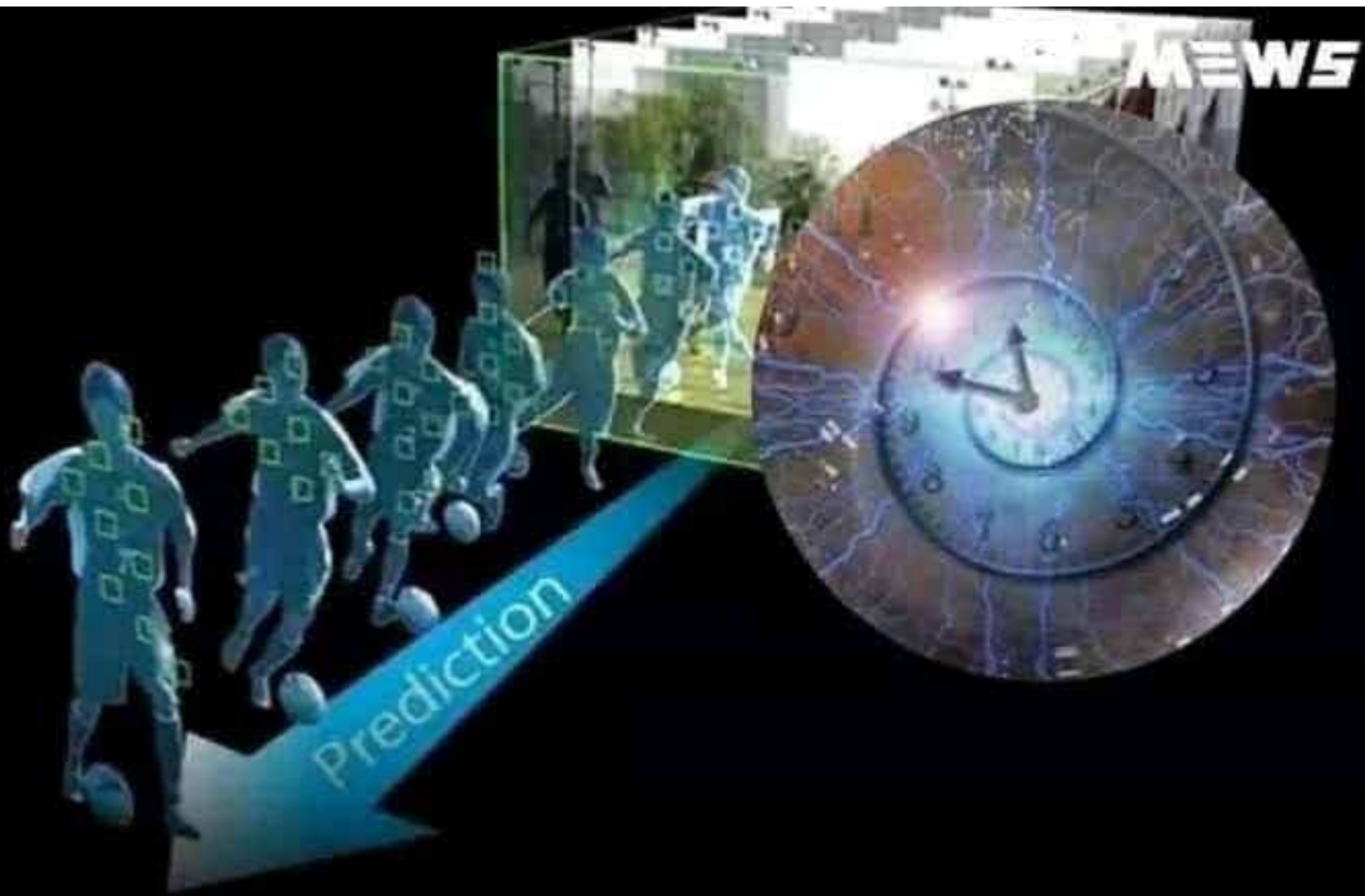

The **fourth dimension is Time** , We can feel this dimension **only moving forward** but we can't go **back in the Time**, Humans can feel only these 4 Dimesnsions.

**ONE UNIVERSE**  
among unlimited material universes

Each universe is ten times the  
massive of the previous counting



Garbhodakalaya Venu

JADA-JAGAT



Dārgā-devī  
sheave of lotus seed

Suryakal (Sun) Brahmā's abode

Saptakā

Jambukā: Seven Sages

Maharukā

Svargāloka (Svarkāloka) Heavenly Planet

(Heaven of 33 Indian Deities and Demons)

Manvāntarā: Kāpāloka and Chitāloka

**Higher Planets**  
(satya)



Śūdrakāloka

Śūdrakā: Earth Planet



**Middle Planet**  
(satya and grow)

Jāṅghāntarā  
(material element)

Atala

Vitala

Sutala

Talātala

Mahātala

Rasātala

Pātala

(Nether material lower than)

**Lower Planets**  
(grow)



GARBHODAKA OCEAN

If we study our Vedas, we will come to know that there are many other planets in this 4 dimensional world where life exists. These Planets are called as Lokas which in descending order are : Satya-loka, Tapa-loka, Jana-loka, Mahar-loka, Svar-loka, Bhuvar-loka, Bhu-loka, Atala-loka, Vitala-loka, Sutala-loka, Talatala-loka, Mahatala-loka, Rasatala-loka, Patala-loka.



The next Dimension is 5th Dimension. This dimension is also called "**Multiple Universe**" or Brahm-Loka where **Lord Brahma** lives. But there's a catch ; **there's not just one Lord Brahma** in the Multiverse **but trillions of them**. Each Brahma creates **one Universe**. This is called 'Creation of the Universe' or **BIG BANG** theory in Science.



Humans live on **Bhu-Loka (Earth)** whereas after death, **the spirit lives in Bhuvan-Loka** and Devas live in **Swarg-Loka**. Though they all **exist in the 3-Dimensional world**.



The Time of 5th Dimension or **Brahma-Loka** is **diffrent** from that of other 4 Dimensions beacause this **Dimension** is too far away from the **other 4!**



The next is 6th Dimension where **Mahavishnu** lives. Mahavishnu also has **three different forms**, which are Mahavishnu, **Garbhodakasayi Vishnu** and **Kshirodkasahay Vishnu**.





Lord Mahavishnu creates the **elements & energy**. These elements & energy creates those **5 Dimensions**. It's also called Mahatatva or **The Supreme element**.



Garbhodakasayi Vishnu creates **multiple Universes** and **multiple Brahmas**. Brahmas appear from a Lotus emerging from the navel of **Garbhodakasayi Vishnu** and then every Brahma creates a separate Universe as **ordered by Garbhodakasayi Vishnu**.

To be continued.....

# FUNCTION OF HEART

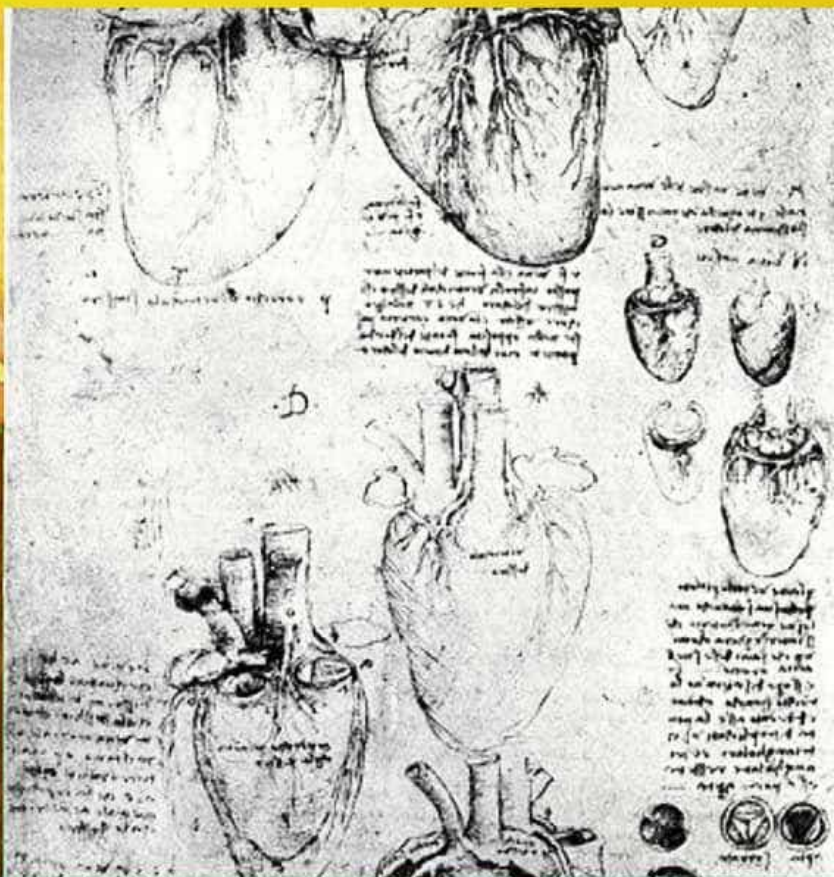
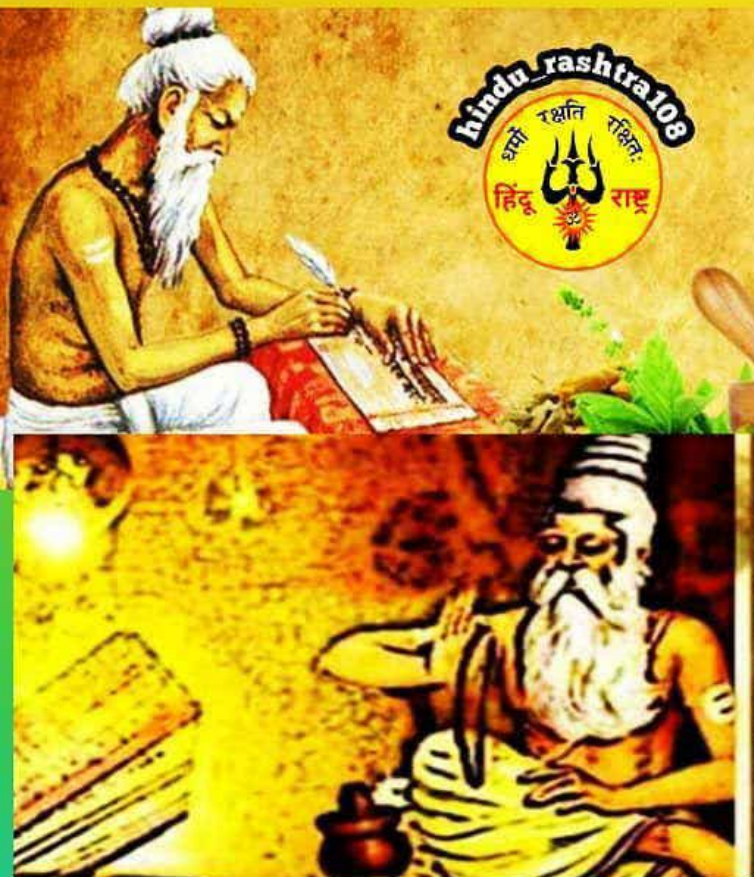

The function of heart was first stated by William Harvey in 17th century. **NO, Naadi Dhyanam** written 7000 years ago states a brief description of heart.

# ANCIENT SPECTROMETER



महर्षि भारद्वाजका Spectrometer

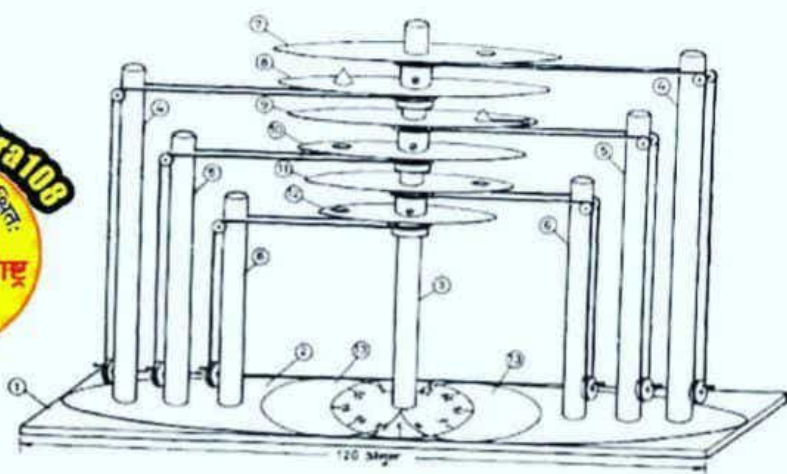

महर्षि भारद्वाज का ध्वान्त (तम) प्रमापक यंत्र  
FIG-1 NOVAL 'SPECTROMETER' OF MAHARSI BHARADWAJA

।। शांरिकानाथः ।।

ध्वान्तप्रमापकं यन्त्रं नवोत्तरशतात्मकम् । द्वात्रिंशदंगसंयुक्तं तन्मोभेदप्रदर्शकम् ।।  
उक्तं हि यन्त्रसर्वस्वे भरद्वाजेन शीमता । तस्य ज्योदशांगेन प्रमातुं तमसो भवेत् ।।  
तस्मादत्र समासेन तदंगं प्रविविच्यते ।।

**Maharishi Bharadwaj discovered Spectrometer that discovered different types of light rays. In the Yantra Sarvasva he explained more than 100 instruments.**

# ANCIENT VIMANA

SHAKUNA VIMANA

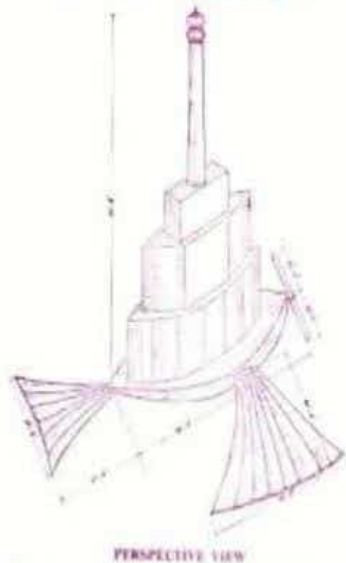

Prepared under instruction of  
Hon. K. S. KRISHNA  
Rajaguru,  
1954-55

SUNDARA VIMANA



Drawn by  
S. K. SIVAPPA,  
Bangalore,  
1954-55

Prepared under instruction of  
Hon. K. S. KRISHNA,  
Rajaguru,  
of Srirangapatna.

TRIPURA VIMANA

PERSPECTIVE VIEW

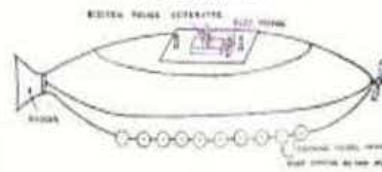

PLAN

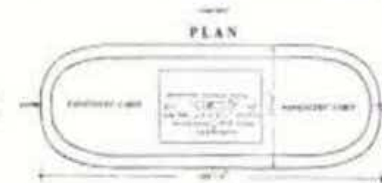
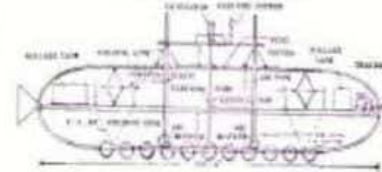

RUKMA VIMANA

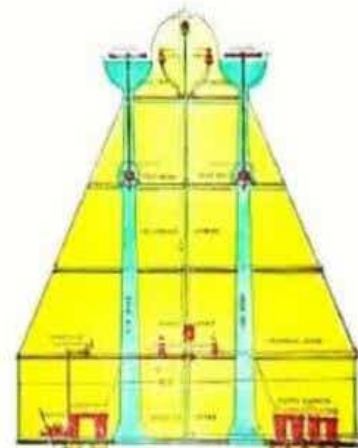

Drawn by  
S. K. SIVAPPA,  
Bangalore,  
1954-55

Prepared under instruction  
from: K. S. KRISHNA,  
Rajaguru,  
of Srirangapatna.

**The Vaimanika Shastra starts with a quantitative description, as though a particular aircraft is being described. The topics covered include, "definition of an airplane, a pilot, aerial routes, food, clothing, metals, metal production, mirrors and their uses in wars, varieties of machinery and yantras, planes like 'mantrik', 'tantrik', and 'kritak'" and four planes called Shakuna, Sundara, Rukma, and Tripura are described in greater detail. The extant text is claimed to be a one-fortieth part of a larger work Yantra Sarvaswa ("All about machines") composed by Maharishi Bharadwaj and other sages for the "benefit of all mankind".**

**Did You Know?**

**Brahman keep Shikha  
(Choti) on the head.**

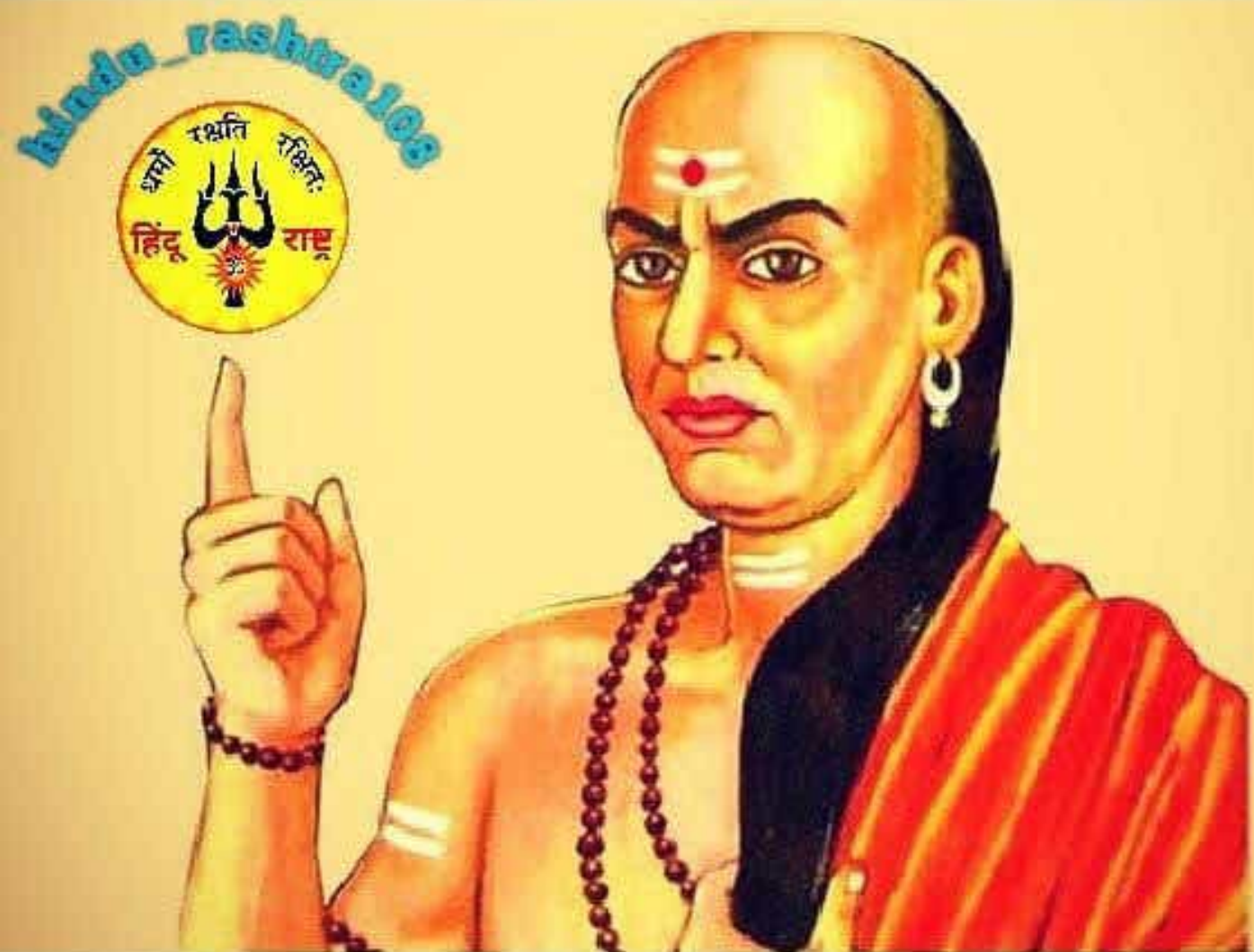

**Why?**

**Swipe To See** 🖱️

**Sushrut rishi, the foremost surgeon of Ayurveda, describes the master sensitive spot on the head as Adhipati Marma, where there is a nexus of all nerves. The Shikha protects this spot. Below, in the brain, occurs the Brahmarandhra, where the sushumnā (nerve) arrives from the lower part of the body. In Yog, Brahmarandhra is the highest, seventh chakra, with the thousand-petalled lotus. It is the center of wisdom. The knotted shikhā helps boost this center and conserve its subtle energy known as Ojas.**



**Did You Know?**

**Janeu are worn by  
Brahman**



**Why?**

**Swipe To See** 🙌



आपने देखा होगा कि बहुत से लोग बाएं कंधे से दाएं बाजू की ओर एक कच्चा धागा लपेटे रहते हैं, इस धागे को जनेऊ कहते हैं। जनेऊ तीन धागों वाला एक सूत्र होता है। यह सूत्र से बना पवित्र धागा होता है, जिसे व्यक्ति बाएं कंधे के ऊपर तथा दाईं भुजा के नीचे पहनता है। अर्थात् इसे गले में इस तरह डाला जाता है कि वह बाएं कंधे के ऊपर रहे।

जनेऊ में मुख्यरूप से तीन धागे होते हैं। प्रथम, यह तीन सूत्र त्रिमूर्ति ब्रह्मा, विष्णु और महेश के प्रतीक होते हैं। द्वितीय, यह तीन सूत्र देवऋण, पितृऋण और ऋषिऋण के प्रतीक होते हैं और तृतीय, यह सत्व, रज और तम का प्रतीक है। चतुर्थ, यह गायत्री मंत्र के तीन चरणों का प्रतीक है। पंचम, यह तीन आश्रमों का प्रतीक है। संन्यास आश्रम में यज्ञोपवीत को उतार दिया जाता है। जनेऊ को उपवीत, यज्ञसूत्र, व्रतबन्ध, बलबन्ध, मोनीबन्ध और ब्रह्मसूत्र भी कहते हैं। जनेऊ धारण करने की परम्परा बहुत ही प्राचीन है। वेदों में जनेऊ धारण करने की हिदायत दी गई है। इसे उपनयन संस्कार कहते हैं। उपनयन का अर्थ है, पास या सन्निकट ले जाना। लेकिन किसके पास? ब्रह्म (ईश्वर) और ज्ञान के पास ले जाना। हिन्दू धर्म के 24 संस्कारों में से एक 'उपनयन संस्कार' के अंतर्गत ही जनेऊ पहनी जाती है, जिसे 'यज्ञोपवीत संस्कार' भी कहा जाता है। मुंडन और पवित्र जल में स्नान भी इस संस्कार के अंग होते हैं।



जनेऊ धारण करने के बाद ही द्विज बालक को यज्ञ तथा स्वाध्याय करने का अधिकार प्राप्त होता है। द्विज का अर्थ होता है दूसरा जन्म।  
जनेऊ धारण करने के निम्न लाभ माने जाते हैं:-

1. बार-बार बुरे स्वप्न आने की स्थिति में जनेऊ धारण करने से ऐसे स्वप्न नहीं आते।
2. जनेऊ के हृदय के पास से गुजरने से यह हृदय रोग की संभावना को कम करता है, क्योंकि इससे रक्त संचार सुचारू रूप से संचालित होने लगता है।
3. जनेऊ पहनने वाला व्यक्ति सफाई नियमों में बंधा होता है। यह सफाई उसे दांत, मुंह, पेट, कृमि, जीवाणुओं के रोगों से बचाती है।
4. जनेऊ को दायें कान पर धारण करने से कान की वह नस दबती है, जिससे मस्तिष्क की सोई हुई तंद्रा कार्य करती है।
5. दाएं कान की नस अंडकोष और गुप्तेन्द्रियों से जुड़ी होती है।
6. कान में जनेऊ लपेटने से मनुष्य में सूर्य नाड़ी का जाग्रण होता है।
7. कान पर जनेऊ लपेटने से पेट संबंधी रोग एवं रक्तचाप की समस्या से भी बचाव होता है।
8. जनेऊ धारण करने से विद्युत प्रवाह रेखा नियंत्रित रहती है जिससे काम-क्रोध पर नियंत्रण रखने में आसानी होती है।
9. जनेऊ से पवित्रता का अहसास होता है। यह मन को बुरे कार्यों से बचाती है।
10. जनेऊ से कब्ज, एसीडीटी, पेट रोग, मूत्रन्द्रीय रोग, रक्तचाप, हृदय के रोगों सहित अन्य संक्रामक रोग नहीं होते



# Pythagoras Theorem OR Theorem of Aryabhata?

All of us have studied in school:  $a^2 + b^2 = c^2$ .  
We called it Pythagoras Theorem.



But, we have not studied in schools is that this theorem was Aryabhata's contribution to the world.

## THEOREM ON SQUARE OF HYPOTENUSE

Aryabhatiyam, Ganitapada

यश्चैव भुजावर्गः कोटीवर्गश्च कर्णवर्गः सः<sup>1</sup> ।

वृत्ते शरसंलग्नोऽर्धज्यावर्गः य खलु धनुषोः ॥ १७ ॥

17. (In a right-angled triangle) the square of the base plus the square of the upright is the square of the hypotenuse.

In a circle (when a chord divides it into two arcs), the product of the arrows of the two arcs is certainly equal to the square of half the chord

This theorem is the theorem of the "the Square of the Hypotenuse", as Hankel has called it. This theorem has been known in India since very early times. Baudhāyana (c. 800 B.C.), the author of the *Baudhāyana-śulba-sūtra*, has enunciated it thus :

"The diagonal of a rectangle produces both (areas) which its length and breadth produce separately."<sup>2</sup>

This theorem is now universally associated with the name of the Greek Pythagoras (c. 540 B.C.), though "no really trustworthy evidence exists that it was actually discovered by him." It were certainly the Hindus who enunciated the property of the right-angled triangle in its most general form. No other ancient nation is known to have made any attempt in this direction.

The second theorem states that if a chord of a circle is drawn, the product of the two segments of the chord is equal to the square of the perpendicular distance from the center of the circle to the chord.

The One who worked on  
**CHEMISTRY** before anyone else was  
"Nagarjuna" in the book रसरत्नाकर.



  
Hinduism\_and\_Science

But world only knows about  
"Antoine Lavoisier"

[Read Caption](#)

## अथ रसशाला ।—

अथ रसशालानिर्माणस्य स्थाननिर्देशः ।—

रसशालां प्रकुर्वीत सर्वबाधाविमर्जिते ।

मर्वौषधिमये देशे रम्ये कूपसमन्विते ॥ १ ॥

यत्त-त्रयत्त-महस्रात्तदिग्विभागे सुशोभने ।

नानोपकरणोपेतां प्राकारेण सुशोभिताम् ॥ २ ॥

अथ रसशालायाः क्व क्व किं कर्म कर्त्तव्यं तन्निर्देशः ।—

शालायाः पूर्वदिग्भागे स्थापयेद्द्रुमभैरवम् ।

वह्निकर्माणि चाऽऽग्नेये याम्ये पाषाणकर्म च ॥ ३ ॥

नैऋत्ये शस्त्रकर्माणि वारुणे चालनादिकम् ।

शोषणं वायुकोणे च वेधकर्मात्तरे तथा ॥

स्थापनं सिद्धवस्तूनां प्रकुर्व्यादौशकोणके ॥ ४ ॥



Fig. 30d.

द्वियामं स्वेदयेदेवं रसोत्थापनहेतवे ।  
 एतत् स्याद्वलभीयन्त्रं रसे षाड्गुण्यकारकम् ॥  
 सूक्ष्मकान्तमये पात्रे रसः स्याद्गुणवत्तरः ॥ ४६ ॥

अथ तिर्यक्पातनयन्त्रम् ।—

क्षिपेद्रसं घटे दीर्घनताधोनालसंयुते ।  
 तन्नालं निक्षिपेदन्य-घटकुक्ष्यन्तरे खलु ॥ ४७ ॥  
 तत्र रुद्ध्वा मृदा सम्यग्वदने घटयोरथ ।  
 अधस्ताद्रसकुम्भस्य ज्वालयेत्तीव्रपावकम् ॥ ४८ ॥  
 इतरस्मिन् घटे तोयं प्रक्षिपेत् स्वादु शीतलम् ।  
 तिर्यक्पातनमेतद्धि वार्त्तिकैरभिधीयते ॥ ४९ ॥

अथ पालिकायन्त्रम् ।—

Hinduism\_and\_Science



चषकं वर्तुलं लौहं विनताग्रोर्द्ध्वदण्डकम् ।  
 एतद्धि पालिकायन्त्रं बलिजारणहेतवे ॥ ५० ॥

अथ पुटयन्त्रम् ।—

शरावसम्पुटान्तःस्थं करौषेष्वग्निमानवित् ।

पचेच्चुल्लगां द्वियामं वा रसं तत् पुटयन्त्रकम् ॥ ४२ ॥

अथ कोष्ठोयन्त्रम् ।

षोडशाङ्गुलविस्तीर्णं हस्तमात्राऽऽयतं समम् ।

धातुसत्त्वनिपातार्थं कोष्ठोयन्त्रमिति स्मृतम् ॥ ४३ ॥

अथ बलभीयन्त्रम् ।—

यत्र लोहमये पात्रे पार्श्वयोर्वलयद्वयम् ।

तादृक् स्वल्पतरं पात्रं वलयप्रोतकोष्ठकम् ॥ ४४ ॥

पूर्वपात्रोपरि न्यस्य स्वल्पपात्रे परिचिपेत् ।

रसं सम्मूर्च्छितं स्थूल-पात्रमापूर्य काञ्जिकैः ॥ ४५ ॥



## QUANTUM PHYSICS FROM BHAGAVAD GITA



### Bhagavad Gita Quantum Physics

Those who worship me As **SAGUNA BRAHMAN** (With Form) OR **NIRGUNA BRAHMAN** (Without Form) Will Finally Attain Me

Every Elementary Entity may Exhibit Both Particle Behavior (With Form) And Wave Behavior (Without Form)

f / i / heritage first



## Did you know...

The game of Chess originated in India ?

A game called 'Chaturanga' mentioned in Mahabharata, which was popular in India by 7th century CE, is the precursor of modern chess.



'Chaturanga' evolved into 'Shatranj', which was spread all over the world by Buddhist monks as well as Persian and Arab travellers.

## Did you know...

f / i / heritage first



Aryabhata had correctly estimated the circumference of earth ?

By estimating the value of pi to be **3.1416**, Aryabhata had concluded the circumference of earth to be **39736 kms**. Today, we know it to be **40,075 kms**. How cool is that!

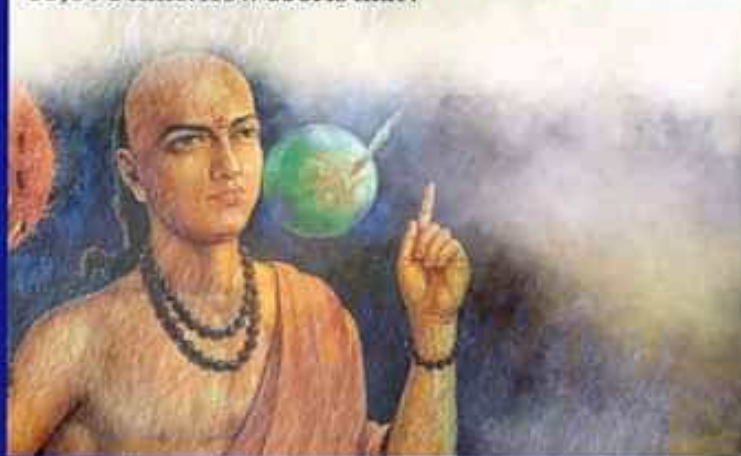

f / i / heritage first



## Boudhayana

(About 800 BC)

He laid the basic principles of Geometry about 500 years before Eculid who is known as 'Father of Geometry'.

His work 'Sulbasutras' was written by him probably for providing rules for constructing religious altars.

But the accuracy of his geometric solutions goes way beyond that was needed by religious rites.

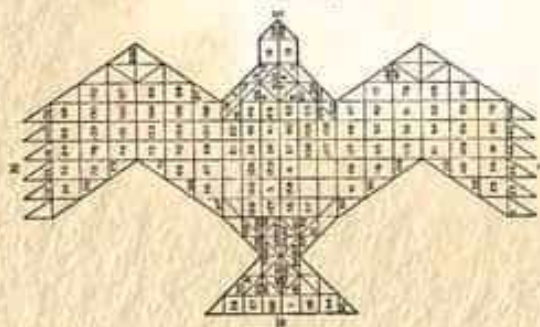

# Manchester Univ. Confirms: This is How Isaac Newton Stole Concept of Gravity from a Hindu Gurukul [mailonnews.com/](http://mailonnews.com/)



16th Century AD

## Laws of motion

Newton vs Rishi Kanad

Thief Newton copied Rishi

Kanad's Vaisheshika Sutra as it is



6th or 2nd Century BC

1) First Law of Motion -

*Kanad* : वेगः निमित्तविशेषात् कर्मणो जायते

Newton: The change of motion is due to impressed force

2) Second Law of Motion -

*Kanad* : वेग निमित्तापेक्षात् कर्मणो जायते नियतिदिक् क्रिया प्रबंध हेतु

Newton: The change of motion is proportional to the motive force impressed and is made in the direction of the right line in which the force is impressed

3) Third Law of Motion -

*Kanad* : वेगः संयोगविशेषाविरोधी

Newton: To every action there is always an equal and opposite reaction

**DO YOU HAVE ANY OLD SPICE BOWL AT YOUR HOME ?**  
**LOOK AT THIS ONE WHICH SURVIVED CENTURIES**



**THIS SPICE BOWL HAS BEEN RECOVERED FROM THE REMAINS OF SINDHU SARASWATI CIVILIZATION AND IS CURRENTLY PRESERVED AT NATIONAL MUSEUM DELHI**

**DO HAVE A CAREFUL LOOK AT IT WHEN YOU VISIT THE MUSEUM NEXT TIME**

Postcard English @Postcard\_news www.postcard.news postcard\_news

**#Ancient Technology**



**What is this ?**



**#Morden Technology**

**Buttons are first invented in India around 5000 years ago**



@SCHOOL\_OF\_VEDIC\_SCIENCE

"The button, in fact, was originally used more as an ornament than as a fastening, the earliest known being found at Mohenjodaro in the Indus Valley. It is made of a curved shell and about 5000 years old



Ancient Painting from Rajasthan. Wonder how the flashlight is working?. Good illustration of the pioneering lifestyle of Bharat when rest of the world were living a primitive lifestyle : A woman with a giant torch mesmerizes a deer. Place of Origin Kotah Rajasthan, Source: The Walters Art Museum, Baltimore,USA

THIS IS NOT ANY SCULPTURE , BUT THIS IS ORIGINAL BODY OF GURU RAMANAJUCHIARYA , PRESERVED IN 1137 CE , INSIDE SRI RANGANATHASWAMY TEMPLE , SRIRANGAM , TIRUCHINARPALLI.



SANDALWOOD PASTE AND SAFFRON ARE USED TO MAINTAIN THE BODY AND NO OTHER CHEMICALS ARE ADDED LIKE IN EGYPTIAN AND GOAN MUMMIES . HIS BODY IS PLACED BEHIND HIS IDOL AND IS OPEN FOR DARSHAN TO ALL DEVOTEES.

A sculpture from Halebidu Temple (12th century) depicting rocket warfare in Ancient India. Notice the launching pad that is holding the missiles/combustible arrows.



THE MOST ANCIENT ASTRONOMERS OF THE WORLD, THE HINDUS



इस्तांबुल के म्यूज़ियम में 3000 साल पहले की एक ऐसी मूर्ती बनी है जिसमें एक बिना सिर के व्यक्ति (अंतरिक्ष यात्री) को रॉकेट जैसे जहाज में बैठा दिखाया है। उस वक्त शायद किसी ने एलियन देखा हो और उसे अपनी कला में उतार दिया।

**ANCIENT INDIANS KNEW SCIENCE OF FERTILIZATION BEFORE INVENTION OF MICROSCOPE**



As we know Britishers represent India as "land of snake charmers" but they are fool they didn't understand this, the above image represents development or progress of human embryo in kala bhairava natha temple, tamil nadu which is atleast 1000 year old.

**Ancient Indians Knew Science of Fertilization without a Microscope?**



The images of fertilization below are from Varamurtheeswarar temple at Ariyathurai, Tamilnadu. Temple is claimed to be 6000 years old based on some legendary aspects.

2500+ yrs ago "GarbhaUpanishad" gave us stages of foetus;

- Day 2: Embryo
- Day 15: Solid Mass
- Month 2: Head Forms
- Month 3: Feet Grows
- Month 4: Belly & Hip
- Month 5: Backbone
- Month 6: Nose, Eyes
- Month 7: Consciousness
- Month 8: Complete



**West found out the same just a few decades ago.**

800 years back indian architects knew what a fetus looked like inside the womb.



Sri Sundara Kamakshi Temple at Siru Karumbur, where Sculpture of a baby in a mother's womb is crafted with clarity along with the accurate position of Baby, As one would find in a scan!

The temple is built by Raja Chola at least 800 years ago.

Incredible Bharat 🇮🇳 🙏

**Science of Fertilisation**



Carvings of different stages of foetus growth in a mother's womb. These carvings were made 1000 years before the invention of any scan technology.

In Pancha Siddhantika, Varahamihira estimated diameters of the planets, like Mercury, Venus, Mars, Saturn and Jupiter.



Apart from these Varahamihira also wrote about the presence of water on Mars (Chapter XVIII). This book had a detailed description of planet Mars. He also wrote in his book that planet Mars has both water and iron present on its surface, which have now been revealed by NASA and ISRO.

## ELECTRICITY IN A CELL

**Shloka:**  
Dastalosto nidhatatvah paradacchaditastatah |  
Utpadayati tanmitram samyogastamradastayoh ||

**Meaning:**  
Lumps of gems generate electricity by the union of copper and zinc

**Shloka:**  
Samyogajjayate tejo yanmitramiti kathyate |  
Evam satanam kumbhanam samyogah karyakrtsmrtah

**Meaning:**  
By the union, energy is born which is referred to as the sun,  
Such a union of hundred of cells is remembered as the doer  
Of generating electricity  
Source: Agniya-samhita (14th Century AD)

## Atomic Theory From Bhagvatgita



caramah sad-visheShanam aneko .asamyutah sada |  
paramanuh sa vigyeyo nrinam aikya bhramo yatah ||  
-Bhagvatgita 3.11.1

The material manifestation's ultimate particle, which is indivisible and not formed into a body, is called the atom. It exists always as an invisible identity, even after the dissolution of all forms. The material body is but a combination of such atoms, but it is misunderstood by the common man.

[Read Article](#)

## Vedic Facts

**Atharva veda 20.15.3**

**This verse gives one to understand that electricity was a topic that was researched and explored in great detail during Vedic age. skilled electrical engineers used to devise specific utilities and control for electrical power.**

## SUSHRUTA SAMHITA 5000 YEARS AGO, SPEAKS OF SEVEN LAYERS OF THE SKIN

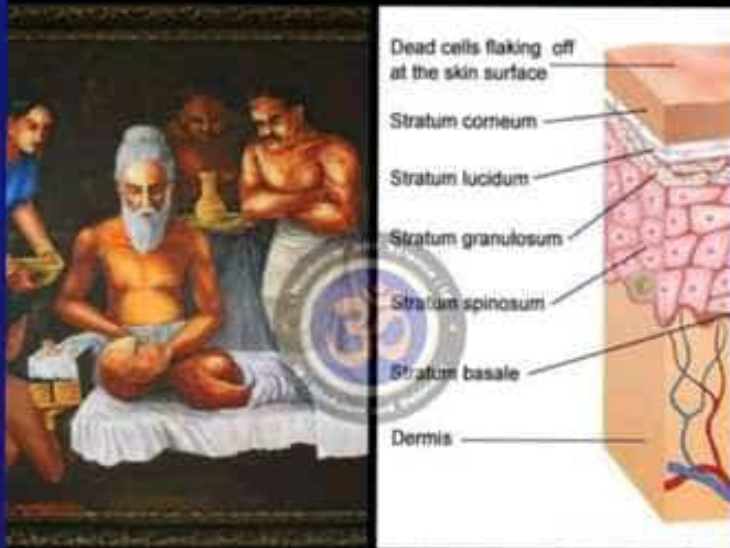

Hinduism Is As Ancient As It Is Modern.

**Kundalini**

**Caduceus**



Kundalini Represents the Medical Caduceus. Two Serpents Spiraling Seven times up a Pole Untile they reach the top at Which Point they Have Wings and Take Flight - Dr. Edward Bynum.

What is Ayurveda ? 🤓🤔



Ayurveda means "The science of life". The sanskrit word Ayur means longevity or life and veda means Science. Ayurveda is known as the mother of all healing science 🙏🕉️

Was **space time relativity** known to Vedic sages?



Vedic scriptures mention - Time flows **differently at different** locations of the universe. Time in **Brahmaloka** being the slowest and **Patala** being fastest. One moment in Brahmaloka is equal to approximately 216 years in Bhumandala

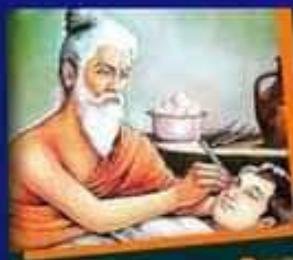

विश्व में सबसे पहले महर्षि सुश्रुत ने सर्जरी की खोज की थी ।

'सुश्रुतसंहिता' ग्रंथ में सर्जरी के 125 औजार और 300 प्रकार की सर्जरी लिखी है ।



भारत में सर्जरी के बड़े विश्वविद्यालय चला करते थे । ब्रिटेन ने भारत से ४०० साल पहले सर्जरी सीखी । फ्रांस, जर्मनी, अमेरिका आदि विश्व के कई देशों ने भारत से सर्जरी करना सीखा है ।

खोज हमारे ऋषि-मुनियों ने अनेक प्रकार की है पर दुर्भाग्य है कि हमें इतिहास में पढ़ाया नहीं जाता है और हम हमारी संस्कृति की महिमा नहीं जानते ।



**Sage Sushruta Statue Unveiled at AIMS, Kochi**

The 40-foot-tall, two-tiered statue has been created by sculptor Chavara Vijayan.

AIMS [Amrita Institute of Medical Science] is also planning to set up a museum in Kochi to showcase the achievements of ancient Indians in all fields of human endeavor.

## AMAZING ANCIENT BHARAT!

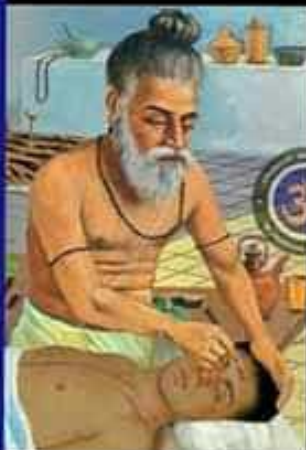

### SUSHRUTA'S INSTRUCTION ABOUT NEEDLES FOR SUTURING

There are numerous details about surgical instruments and surgery in Sushruta Samhita, written 5000 years ago. But two shlokas about needles read like latest surgical needle story.

## NO DOCTOR WILL LAUGH AT SUSHRUTA TODAY

5000 YEARS AGO Sushruta wrote in his Encyclopedia of Medicine that



- 1) Bones are vital to the body because BONE MARROW produces life-saving essence.
- 2) Muscles are bound to the bones using tendons.





**Bhaskaracharya was 1st to discover gravity than Sir Issac Newton.**

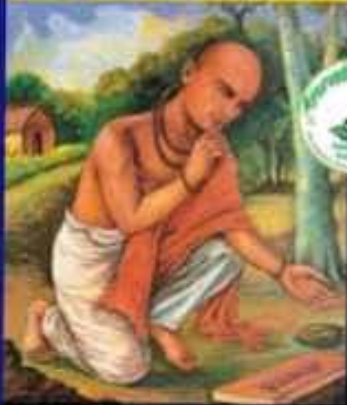

**Ayurveda and Yoga**

He discovered gravity in 12th century, 500 years earlier than Newton. He also calculated the time taken by earth to revolve sun: 365.258756484 days. He was champion among the mathematicians of his time.

[ayurvedandyoga](#)

[ayurvedandyogaofficial](#)

## Force of Gravity

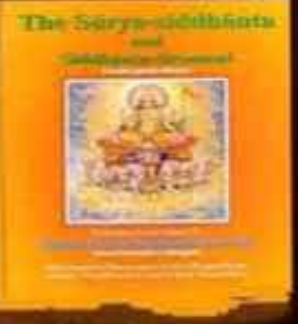

The first principle of gravity was stated by "Bhaskaracharya" and "not Newton"

Bhaskaracharya stated the laws of gravity in the book Surya Siddhanta in 11th century. Thus the law actually exists even before the birth of Sir Isaac Newton (Newton was born in the 16th century).

We all think **Newton** discovered **Gravity**, but do you know he never took the credit for it? Why?



@youngndharmic

Gravity was mentioned in the **Vedas**. 1100 years before Newton was born, a Hindu Astronomer, **Varahamihira** paraphrased **Aryabhata** and said "the earth remains suspended in the sky by a force, just like a piece of iron is held in the grip of a magnet"

## ARYABHATA EXPLAINS POLAR WINDS, SOLASTICE AND EQUINOX



**The Globe [Golādhyāya] is the chapter in Mahā-Siddhānta of Aryabhata, where all these phenomena are explained in detail**

## Our Sages, Our Scientists

A Son of Bharat in 600 BCE, identified 5 mosquito species as source of a "King of Diseases" causing chills & fever.



For next 2500 yrs West thought it was caused by Bad Air & named it **MALARIA**: Mal = Bad, Aria = Air.

The function of heart was first stated by william harvey in 17th century.

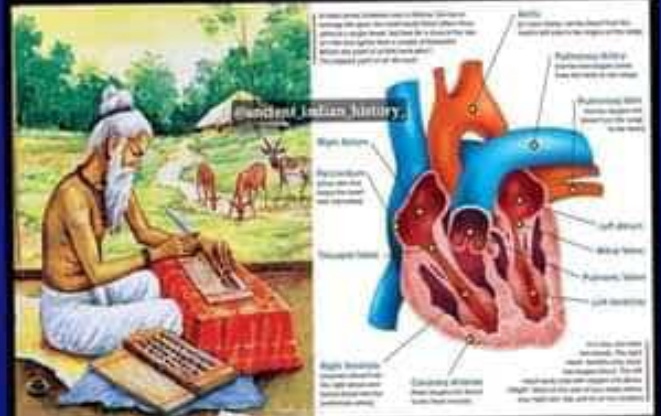

No, Bharatiya literature "Naadi Dnyanam" Written 700 years ago already stated the brief description of human heart.

## BONES AND LIGAMENTS - SUSHRUTA



Sushruta Mentioned the number of bones and ligaments PERFECTLY.

## DID YOU KNOW?

ACCORDING TO THE TAITTIRIYA UPANISHAD (2.1-5) YAJUR VEDA THERE ARE FIVE SHEATHS (COVERINGS/ LAYER) IN THE BODY COVERING THE ATMA.

### THE BELOW ARE THE 5

1. **ANNAMAYA KOSHA- FOOD SHEATH-** It consists of flesh, bones, fat, skin etc.
2. **PRANAMAYA KOSHA- THE VITAL ENERGY-**The force holds together body & the mind.
3. **MANOMAYA KOSHA-MIND SHEATH-** Mind along with 5 sensory organs.
4. **VIJNYANAMAYA KOSHA-THE INTELLECTUAL FACULTY-** It consists of organs which helps to decide or discriminate.
5. **ANANDAMAYA KOSHA- THE BLISS SHEATH-THE SEAT OF GOD-** This Kosha comprises of supreme bliss, which is the reflection of BRAHMAM-ATMA CONNECTION.

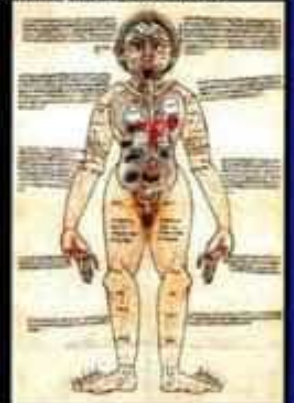

## SCIENCE & SPIRITUALITY OF ANCIENT BHARAT !!



SINCE MANY MILLENNIA WE CELEBRATE MAHA-KUMBH EVERY 12 YEARS BASED ON BRAHASPATI CYCLE.

WHILE WEST CAME TO KNOW JUST FEW CENTURIES AGO, OUR ANCIENTS KNEW 1000S OF YEARS AGO THAT JUPITER (BRAHASPATI) COMPLETES ONE CYCLE AROUND SUN IN 12 YEARS

www.vedsci.in

## हिन्दू कालगणना सूक्ष्मतम से विराटतम



अद्वैत विद्यापीठ अर्वाङ्कित

हिन्दू कालगणना सूर्य एवं चन्द्र दोनों की गति पर आधारित विश्व की सबसे व्यापक कालगणना है।

यहाँ आधुनिक दुई इस्वी अन्वयक कल्पगणना है।

इसमें पूर्वम अन्वयकगणनाओं को भी भेदका लेना-सोचना में आधुनिकता किया जाने है। अतः इनमें काल की इस्वी व्यापक गणना की जाती आधुनिकता है।

इसमें हाथकायक कल्पना व मानिने। कपरीक एसा मानका अन्य उन वैज्ञानिकों का भी उपहास करि, जो अन्वयक पर पहेल मुक हैं और अन्य हसी पर जाने का प्रयत्न कर रहे हैं।

महाभूति युग कीर्ति

२ परमाणु	= १ अणु
३ अणु	= १ प्रमाणु
३ प्रमाणु	= १ मुटि
१०० मुटि	= १ वेध
३ वेध	= १ लय
३ लय	= १ निमेष
३ निमेष	= १ क्षण
५ क्षण	= १ काण्डा
३० काण्डा	= १ कला
१५ काण्डा	= १ लघु
१५ लघु	= १ नाडिका
२ नाडिका	= १ मुहूर्त
३० कला	= १ पहर
३० मुहूर्त	= १ दिनरात (अहोरात्र)
७ दिनरात	= १ सप्ताह
२ सप्ताह	= १ पक्ष
२ पक्ष	= १ मास
२ मास	= १ ऋतु
३ ऋतु	= १ अध्वन (६ माह)
२ अध्वन	= १ वर्ष

www.vedsci.in

## हिन्दू कालगणना सूक्ष्मतम से विराटतम

कल्पयुग की अवधि	= ४,३२,००० वर्ष
द्राघयुग की अवधि (कल्पयुग से युगी)	= ८,६४,००० वर्ष
अन्वयुग की अवधि (कल्पयुग से तीन युगी)	= १२,९६,००० वर्ष
महायुग की अवधि (कल्पयुग से चार युगी)	= १७,२८,००० वर्ष

१ चतुर्दशी (सारी युगी का योग)	= ४३,२०,००० वर्ष
१ मन्वन्तर	= ७१ चतुर्दशी
अन्वय (१ मन्वन्तर = १४ X ४३,२०,००० वर्ष)	= ३,०६,७२,००० वर्ष

दो मन्वन्तर के बीच एक सप्तमहा योनि है। जो एक महायुग के अन्त में होता है।

संघर्षा	= १७,२८,००० वर्ष
१ कल्प = १४ मन्वन्तर व संघर्षा के १५ महायुग का योग	
अन्वय (१४ X ३,०६,७२,००० वर्ष) + (१५ X १७,२८,००० वर्ष)	

१ कल्प	= ४,३२,००,००,००० वर्ष (४ लाख ३२ करोड़ वर्ष)
--------	---

एक महायुग का १ दिन और उसकी दो अवधि की एक होती है।

१ दिनरात (४ लाख ३२ करोड़ वर्ष X २)	= ८,६४,००,००,००० वर्ष
------------------------------------	-----------------------

ब्रह्मा का १ वर्ष	= ३१,१०,४०,००,००,००० वर्ष (३१ लाख १० हजार ४० करोड़ वर्ष)
-------------------	--

ब्रह्मा के १०० वर्ष	= विष्णु का एक निमेष
---------------------	----------------------

(३१ लाख १० हजार ४० करोड़ वर्ष X १००)	= ३१ नील १० लाख ४० हजार वर्ष
--------------------------------------	------------------------------

विष्णु के १०० वर्ष	= एक माह १ दिन
--------------------	----------------

रुद्र स्वर्ग कालरूप है और अनन्त है, इसीलिये कहा जाता है - काल अनन्तानन्त है।

संस्कृत-प्राकृत-भाषाविभाग:

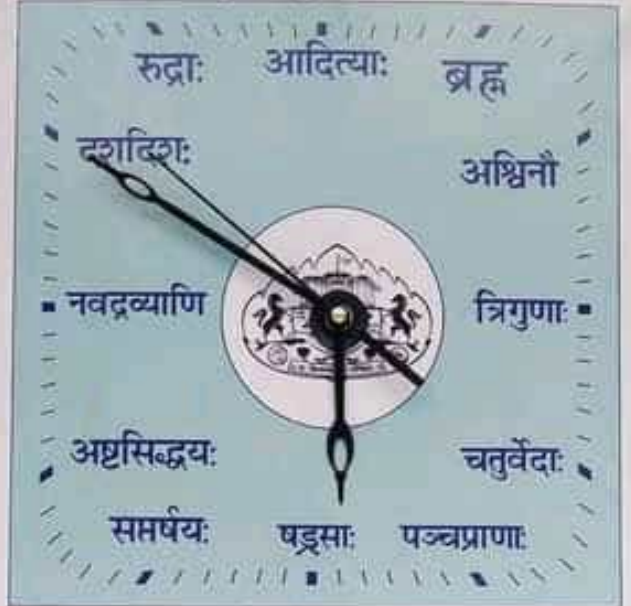

सावित्रीबाई-फुले-पुणेविद्यापीठम्।

# SURYA NAMASKAR



ASANA	BREATH	CHAKRA	BENEFITS
Pranamasana	Inhale & Exhale	Anahata (Heart)	Induces a sense of calm and introspection.
Hasta Uttanasana	Inhale	Vishuddhi (Throat)	Stretches the chest & abdomen lifting the Prana to the upper body.
Padahastanasana	Exhale	Muladhara (Root)	Stretches hamstrings and blood flows to the brain. Prana travels to the lower body.
Ashwa Sanchalanasana	Inhale	Ajna (Third Eye)	Improves hip flexibility and stretches groin muscles.
Adho Mukha Dandasana	Hold breath in	Vishuddhi (Throat)	Strengthens core abdominal muscles, arms, wrists, upper back & neck.
Ashtangasana	Exhale	Swadhisthana (Spleen)	Increases blood flow to the chest and strengthens the arms & shoulders.
Bhujangasana	Inhale	Muladhara (Root)	Relieves tension in the lower back & gives an expansion to the abdomen & chest.
Parvatasana	Exhale	Vishuddhi (Throat)	Strengthen arms, shoulders & legs & stretches the calf muscles. Increases blood flow to the brain.
Ashwa Sanchalanasana	Inhale	Ajna (Third Eye)	Improves hip flexibility and stretches groin muscles.
Padahastanasana	Exhale	Muladhara (Root)	Stretches hamstrings and blood flows to the brain. Prana travels to the lower body.
Hasta Uttanasana	Inhale	Vishuddhi (Throat)	Stretches the chest & abdomen lifting the Prana to the upper body.
Pranamasana	Exhale	Anahata (Heart)	Induces a sense of calm and introspection.

## AWAKENING CHAKRAS WITH MUDRAS and MANTRAS

<b>LAM</b>		<b>ROOT CHAKRA MULADHARA (SURVIVAL)</b> Base of Spine, to Perineum		Thumb & Index Fingers touch. Index Straight, Fingers on knees. Chakra Sound... Long L-A-A-A-M
<b>VAM</b>		<b>SACRAL CHAKRA SWADHISTHANA (CREATIVITY)</b> Hip		Place hands in your lap with your palms facing upwards, right palm resting on top of left. Chakra Sound... Long V-A-A-A-M
<b>RAM</b>		<b>SOLAR PLEXUS CHAKRA MANIPURA (WILL POWER)</b> Two inches below Heart		Place Hands between your heart and your stomach. Chakra Sound... Long R-A-A-A-M
<b>YAM</b>		<b>HEART CHAKRA ANAHATA (LOVE)</b> Heart		Right Hand, Index Finger & Thumb touching at Heart Center. Left Hand in same Mudra resting on the Knee. Chakra Sound... Long Y-A-A-A-M
<b>HAM</b>		<b>THROAT CHAKRA VISHUDHI (EXPRESSION)</b> Throat		Hand by Stomach, Fingers interlaced & thumb tips touching. Focus on Throat Chakra. Chakra Sound... Long H-A-A-A-M
<b>SHAM</b>		<b>THIRD EYE CHAKRA AJNA (INTUITION WISDOM)</b> Third Eye		Hands in front of the lower part of your spine. Middle fingers stand up right touching, other fingers bent at first joint as shown. Chakra Sound... Long S-H-A-A-A-M
<b>OM</b>		<b>CROWN CHAKRA SAHSAJANA (SPIRITUAL CONNECTION)</b> Crown		Hands in front of your stomach, fingers interlaced. Little fingers pointing upwards. Chakra Sound... Long O-O-M-M-M

## Lord GANESHA: God of TRANSPLANT SURGERY



### Ganesha - World's 'first' Xenotransplant

➡ The transplant is believed to have been performed by Lord Shiva.

Today, with shortage of organs the world over, the attractive option of using animal organs is being explored all the time. If research could overcome rejection (antigen- antibody reaction), then, using animal body parts for humans could become a reality.

@ayurveda\_lovers

## vedic facts



A tradition of veterinary therapy developed very early in India and this has survived to the present time .

Based on the Ayurveda (knowledge concerning longevity), a medical art which had its roots in the literature of the Veda written between (1500-1000 BC)

Veterinary medicine is known for its specialised literature, which provides information on ancient methods of preventing and treating diseases of animals before the advent of modern medicine. Some of these treatments, little known outside India, are still practised today

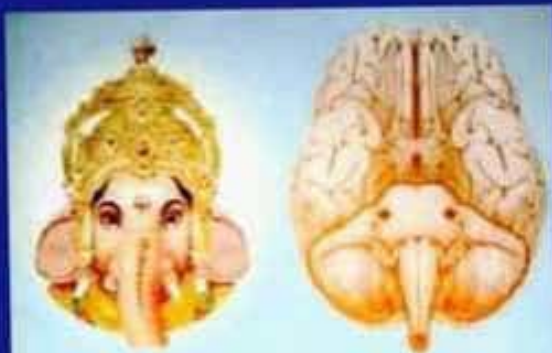

The ventral view of the brain, (the brain seen from underneath), shows the clear correspondence between Ganesh and the pons, medulla, and cerebellum. The face of Ganesh corresponds to the pons. The medulla represents the trunk of Ganesh. The roots of the trigeminal nerves represent the eyes of Ganesh. A group of nerves at the pons represent the tusks of Ganesh. The cerebellum constitutes the ears of Ganesh. These structures not only look like Ganesh, but their functions in human physiology correspond to the functions and activities ascribed to Ganesh. (See pp. 341-347, *Human Physiology: Expression of Veda and the Vedic Literature*)

### DID YOU KNOW?

ACCORDING TO THE TAITIRIYA UPANISHAD (2.1-5) YAJUR VEDA THERE ARE FIVE SHEATHS (COVERINGS/ LAYER) IN THE BODY COVERING THE ATMA.

#### THE BELOW ARE THE 5

1. ANNAMAYA KOSHA- FOOD SHEATH- It consists of flesh, bones, fat, skin etc.

2. PRANAMAYA KOSHA- THE VITAL ENERGY-The force holds together body & the mind.

3. MANOMAYA KOSHA-MIND SHEATH- Mind along with 5 sensory organs.

4. VIJNYANAMAYA KOSHA-THE INTELLECTUAL FACULTY- It consists of organs which helps to decide or discriminate.

5. ANANDAMAYA KOSHA- THE BLISS SHEATH-THE SEAT OF GOD- This Kosha comprises of supreme bliss, which is the reflection of BRAHMAM-ATMA CONNECTION.

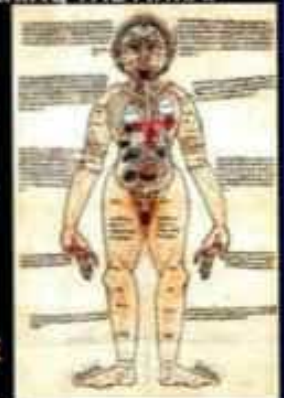

SPIRITUALITY\_DECODED

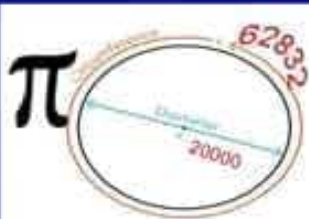

From this statement  $\pi = \frac{62832}{20000} = 3.1416$ .

How Āryabhaṭa arrived at this value of  $\pi$  has been suggested by Bhāskara in his commentary on ŚŚ, Golādhyāya, Bhuvanakośa, 52. He states that if a circle with 10000 units as radius is drawn, and if a portion of the circumference less than even its hundredth part is considered and if by the method of construction of a table of Jyā the chord subtending this arc is calculated, the circumference of the circle is nearly equal to the chord multiplied by the number of parts into which the circumference is divided. He further adds that this is the reason why Āryabhaṭa has said that when the diameter of a circle is 20000 units, the circumference is 62832 units.

Prof: Bina Chatterji



VALUE OF PI

चतुरधिकं शतमष्टगुणं  
द्विषच्चटिस्तथा सहस्राणाम् ।  
अयुतद्वयविष्कम्भस्य आसन्नो

वृत्तपरिणाहः । शार्ङ्गभटीयम्

ADD FOUR TO ONE HUNDRED  
MULTIPLY BY EIGHT THEN ADD  
SIXTY TWO THOUSAND THEN DIVIDE  
BY TWENTY THOUSAND RESULT IS  
APPROXIMATELY CIRCUMFERENCE  
OF A CIRCLE OF DIAMETER OF  
TWENTY THOUSAND .

Aryabhata called it  
an approximate (asanna) value

VALUE OF

$$\pi = \frac{\text{circumference}}{\text{DIAMETER}} = \frac{62832}{20000} = 3.1416$$

The science of ancient India



Sri Yantra (OM) Mandala      OM sound on a Tonoscope

Science proving the Rishi's Right.

A comparison of the similarities between the Sri Yantra Mandala and a Tonoscope picture of the sound OM. The Sri Yantra mandala is thousands of years old

Kaṇāda's Laws of Motion

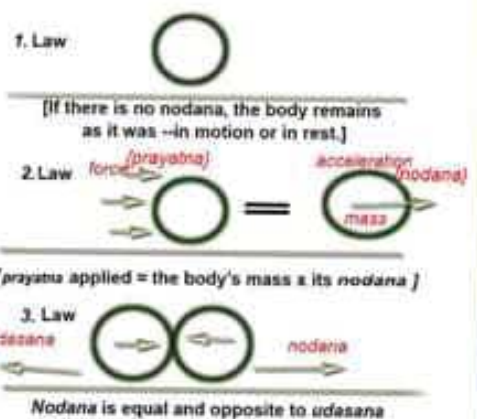

Kaṇāda's Laws of Motion

1. nodana-viśeṣṭa abhāvāt na Ḡrdhvam na tiryag-gamanam 5.2.8
2. prayatna-viśeṣāt nodana-viśeṣaḥ 5.2.9
3. nodana-viśeṣāt udeśana-viśeṣaḥ 5.2.10

Ancient Egypt

Present Day

Ancient India



**Uraeus**  
(Staff of Osiris)

**Caduceus**  
(Am. Med Assoc.)

**Kundalini**  
(Spiritual Art of India)

"The Uraeus (Ancient Egypt) or Kundalini (Ancient India), represents the medical Caduceus...two serpents spiraling 7 times up a pole until they reach the top at which point they have wings and take flight." ~ Dr. Edward Bynum



THE INVENTION OF LUDO IS CREDITED TO ALFRED COLLIER, 1891.



However, the 1000` s of years back Mahabharata mentions Chaupar, a similar game. The Skanda Purana mentions Lord Shiva and Parvati playing Pasichi, a similar game. This has also been carved on the Ellora Caves. Coincidence? .

Bhoja Prabandhan is an 11th century Ancient Indian Book which describes information about Brain Surgery. It was written by 2 Brahmin brother's from the school of Ujjain, who were hired to cure King Bhoja who was afflicted by a tumor in his brain.



After successful brain surgery, Brahmin brother's wrote this book. They artificially induced a coma with a special preparation known as the Sammohini (anesthesia) and then opened king's skull to remove the tumor. King was then brought back to consciousness with another drug!!

## AEROPLANES IN ANCIENT BHARAT



Samarangana-Sutradhara - In this book, There is mention of several Types Of Aeroplanes Which Were In Use Then Or in the Past





## RIG VEDA & SOLAR SYSTEM



Solar System



Rig Veda

Before COPERNICUS Rig Veda noted the position of Sun, Earth And Other Planets  
Read Caption

Kurukshetra

## The Law Of Conservation Of Energy In Bhagavath Gita



Soul Can Neither Be Created Nor Destroyed. It Just Transfers From One Body To Another.



Energy Can Neither Be Created Nor Destroyed - Only Converted From One Form Of Energy To Another.

@HINDUISM\_AND\_SCIENCE

## SPEED OF LIGHT IN RIG VEDA



Sayana, a vedic scholar from the 14th century once said, "With deep respect, I bow to the sun, who travels 2202 yojanas in half a nimesha"  
A yojana is 9 miles; a nimesha is 16/75 of a second. Therefore 2202 yojanas x 9 miles x 75/8 nimesha = 185,794 miles per second or 2.99,000 kilometers per second.

That's astonishingly close to the real scientifically proven 3,00,000 kilometers It's often believed that his source was none other than the Vedas

## Hitler Invited Dandibhatla Viswanatha Sastry to Decode Vedas & Build Missiles and Weapons

@sanatan is alive



Read Caption

Viswanatha Sastry was a child prodigy who studied tarka (logic), vyakarana (grammar), mimamsa (dilemma) and mastered the entire Yajurveda karma kANDa bhAga and atharveda mantra prayoga bhAga (application part). His portrait is still hung on a wall at a University in Frankfurt, Germany.

# Sage Atreya

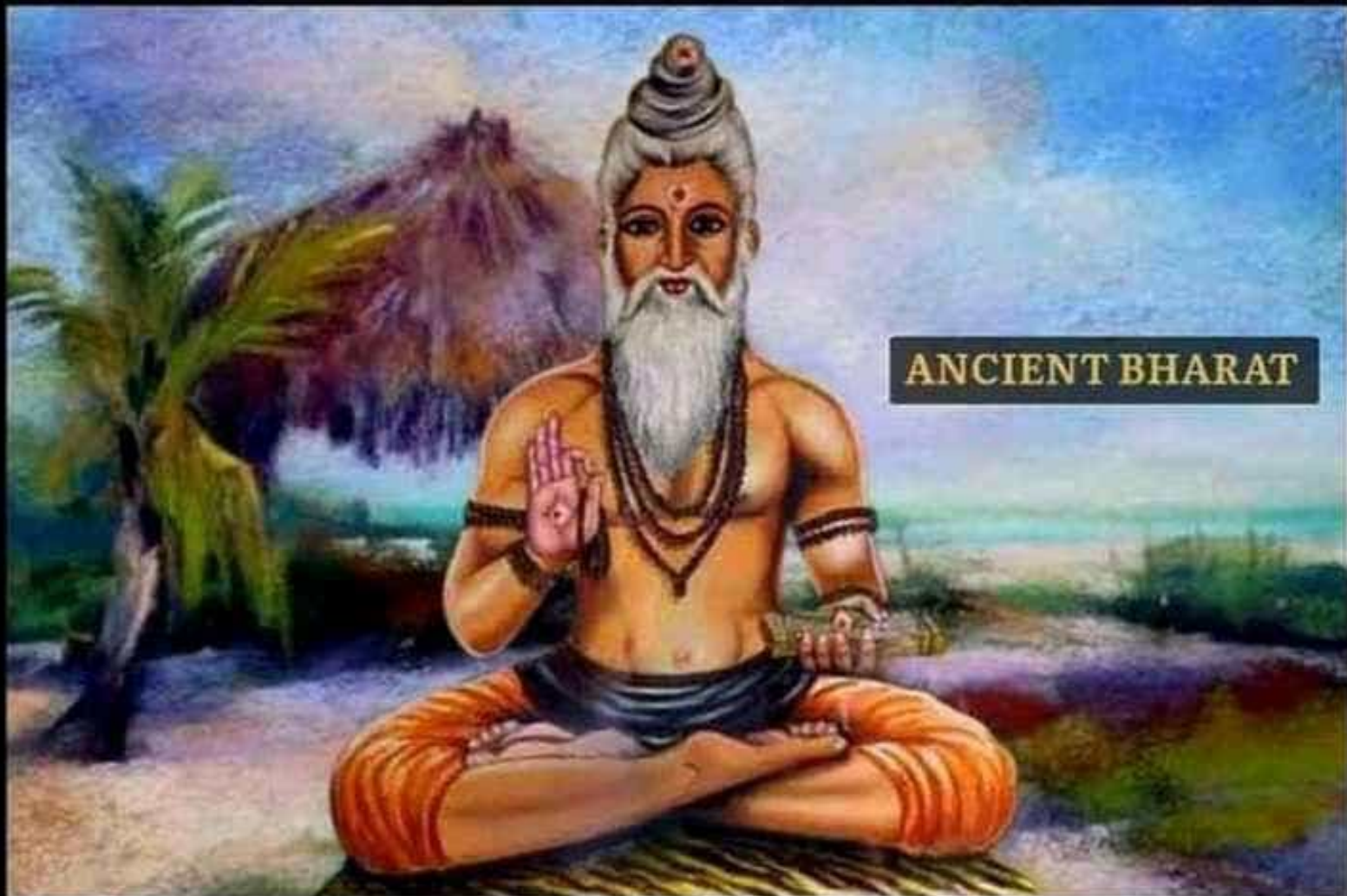

ANCIENT BHARAT

Atreya (700 - 600 B.C.) was an eminent sage and a pupil of Bharadwaja at Taxilla (Taksasila) situated on the banks of the river Sutlej now in Pakistan. He taught medicine and ushered in the age of scientific medicine through his astute observations of symptoms, disease and their correlation. He is rightly known as the "Hippocrates of Ancient Indian Medicine" as well as the "Father of Indian Medicine". Charak was one of his students.

A 5500 YEAR OLD SUMERIAN STAR MAP, COMPARED TO NASA GOLDEN DISC SENT INTO SPACE. WAS THE ANCIENT STAR MAP ALSO A DISC SENT TO US TO LEARN AND EXPLORE THE COSMOS? IS HISTORY BEING REPEATED HERE?



## ART OF NAVIGATION WAS BORN IN RIVER SINDHU 6000 YEARS AGO



THIS ASTROLABE (USED AS ANCIENT NAVIGATION SYSTEM) IN THE GENEVA MUSEUM OF SCIENCE HISTORY.

ZOOM IN AND SEE! THE LETTERS ALL HAVE SANSKRIT SCRIPT AND OUR RISHIS ARE DEPICTED. FROM AROUND THE 14TH CENTURY. PROOF OF INDIA'S STRONG ASTRONOMICAL PROWESS!!

## DID YOU KNOW?



SPIRITUALITY, DECODED

### NAVIGATION BEGAN IN ANCIENT BHARAT: INDUS VALLEY PEOPLE USED MONSOON WINDS FOR SAILING 4500 YEARS AGO!

People of Ancient Bharat had knowledge of harnessing monsoon winds for navigation long before Hippalus, the Greek mariner & acclaimed discoverer of monsoon winds, according to a study by the National Institute of Oceanography (NIO) in Goa. "The people of Indus Valley Civilisation were already using monsoon wind and currents for maritime trade and navigation in 2500 BC," NIO scientist Sila Tripathi has reported in a recent issue of the journal Current Science.

## THIS IS HOW VEDAS EXPLAIN HELIOCENTRIC MODEL OF OUR SOLAR SYSTEM



### पंचारचे परिवर्तमाने तस्मिन्ना तस्थर्भुवनानि विश्वा।

As a wheel rotates on its Axis. In the same mechanism all the planets rotate around their Axis and revolves around the Sun.

- RICVED 1.164:13

One of the world's most mysterious book is 'Surya Siddhanta'. According to Hinduism Surya Siddhantha was given by Surya himself to Raavana. Oldest version of Surya Siddhantha we have today is of 15th century written on palm leaf. It was also used before 15th century and was transferred orally to next generation



This book gives the rules to calculate the motions of various planets and the moon relative to various constellations, and calculates the orbits of various astronomical bodies and guess what..it was written before humans thought that Earth was flat 😊

### THIS IS HOW VEDAS EXPLAIN HELIOCENTRIC MODEL OF OUR SOLAR SYSTEM



**पंचारचे परिवर्तमाने तस्मिन्ना तस्थर्भुवनानि विश्वा।**

As a wheel rotates on its Axis. In the same mechanism all the planets rotate around their Axis and revolves around the Sun.

- RICVED 1.164:13

### WHAT INDIANS PRACTICED NEWTON DISCOVERED (after gravity, it is dispersive refraction)

MODERN UNDERSTANDING OF LIGHT AND COLOUR (ISSAC NEWTON -1622)



DIVINE SUN IN A CHARIOT DRIVEN BY SEVEN HORSES; EXPLAINED AS 'SAPTHA ASVA RUDA' (INDIAN RISHIS 7000 YRS BEFORE ISSAC NEWTON)



RA, THE SUN GOD OF EGYPT (2494 – 2345 BC) IS PICTURIZED AS A MAN WITH A PHORADH'S CROWN AND A SUN DISK ABOVE IT ..NO CHARIOT NO HORSES

SUN OF GREEK MYTHOLOGY CAME NEAR TO INDIANS... BUT THEIR SUN GOD 'HELIOS' HAD ONLY 4 HORSES TO DRIVE HIM



PHOTO TO BE SHOWN IN INDIA

### DID YOU KNOW?



### SCIENCE BEHIND THE HORSES OF SURYA DEV- REFRACTION OF LIGHT!

One of Surya Deva's names is "Saptashuan" (Sapta + Ashuan), which means there are seven horses (Gayatri, Brihati, Ushnih, Jagati, Trishtubha, Anushtubha and Pankti) in His chariot. But the word, "Ashuan" also means "rays". The meaning of Saptashuan could be interpreted as Sun having rays that are capable of emitting seven different colours. It is one ray that refracts into seven colours. That is how VIBGYOR is seen. Taittiriya Aranyaka of Veda categorically proclaims that it is only one ray, which has seven names. It is only the white colour that emits seven colours due to refraction.

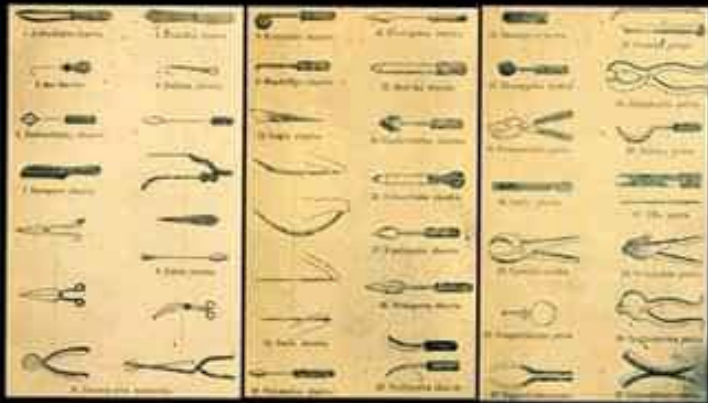

Sushrut used 125 types of surgical instruments including scalpels, lancets, needles, Catheters and rectal speculum designed from the jaws of animals and birds. He has also described a number of stitching methods; the use of horse's hair as thread and fibers of bark.

A few surgical instruments of SUSHRUTA [5000 years ago]

कङ्कसमुखम्



सिन्हास्यम्



प्राक्तमुखम्



काण्डमुखम्



सर्पफणास्त्रम्



A few latest modern surgical instruments

Legit Desk Miller Forceps

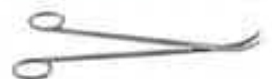

## Sushruta in India

 Dyindia.com  
@Dyindia\_com

Kerala state board Class 9 textbook distorts history, claims Abu al-Qasim Al-Zahwari was the 'Father of Surgery' instead of Sushruta



Kerala textbook changes father of surgery to secularise education  
dyindia.com

Omitted out from textbooks to secularise education

## Sushruta in Foreign countries



Australia built 40 ft tall statue crediting him as father of surgery

**Something you must know about Swami Vivekananda with Nikola Tesla!**



Swami Vivekananda and Tesla discussed the notions of prāna, ākāsha, and kalpas, three elementary concepts of the Vedantic doctrine.

Swami Vivekananda shared with Tesla the conception of matter(ākāsha) and energy(prāna) to be one, and requested him to prove it via maths. But Tesla failed to accomplish it. Swami Vivekananda also communicated with the other two giants of Western science, namely William Thomson (Lord Kelvin) and Von Helmholtz in New York. Finally after 10 years, in 1905, Albert Einstein substantiated the oneness of matter and energy ( $E = mc^2$ ).



dfsc.hinduism

Shakuni's Gaandharraj (Present day Pakistan/Afganistan) were well versed in music & art's. It was also named after one of the saptaswara (Shadaja, Rishabha, Gandhara, Madhyama, Panchama, Dhaivata, Nishaad, Shadaja) Sa-Re-Ga-Ma-Pa-Da-Ni-Sa



There is only one temple dedicated to Shakuni in Pavithreshwaram Kollam, Kerala. A large granite stone inside the shrine is believed to be the seat where Shakuni performed his penance.



Vedas:	Western Scientists:
<b>Earth is Spherical</b>	<b>Earth is Spherical</b>
	
oh! it's Hindu Science..., it's Mythology	Wow! what a discovery by west
	
Traitor leftist historian/ so called cool dudes	

**Maharishi Kanada** invented **atomic theory** at least **2500 years** before **John Dalton**, before 600 BC



He stated that **the smallest indivisible form of matter is parmanu**. He even explained the **dimensions, motions** and even the **chemical reactions** of parmanu and its compound forms

गणित में हम भारतीय कितना आगे थे इसका अंदाजा आप इसी बात से लगा सकते हैं कि अंग्रेजी शब्द "geometry" संस्कृत के शब्द "ज्यामिति" से लिया गया है जिसका अर्थ है पृथ्वी का मापन।



From the very same point of view you can imagine that how much advance were indians in mathematics, that the word "geometry" is itself derived from the Sanskrit word "ज्यामिति", which means measurement of earth.

## VEDANGA JYOTISHA

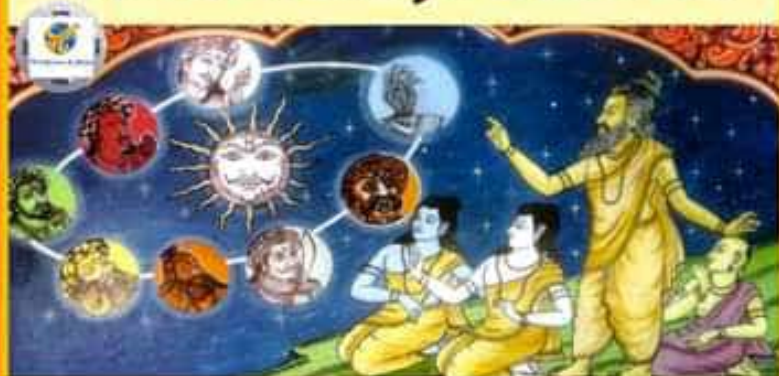

Astronomy is the main subject of the text Vedanga Jyotisha. Even during Rigvedic times astral sciences were highly developed where people acquired knowledge of the movement of sun and moon for knowing the seasons which was important in performing yajnas such as Darsapurnamasa and Chaturmasya. Ancient people had knowledge of the calculations for eclipses, full moon (Amavasya) and new moon (Purnima) days, of stellar constellations as it is required for determining the commencement of specific Yajnas.



## Spectrometer

Maharshi Bharadwaj discovered different types of light rays. Maharshi Bharadwaj discovered Spectrometer. In his "Yantra Sarvasva" he explained about more than 100 instruments.

Ancient Indian History

## ॥ सौरमण्डल ॥

बौद्धिक मशीनियों को असादि काल से ही ज्ञात था कि पृथ्वी और अन्य ग्रहों का सारलक्षिक अकारण रूप है।

सौरमण्डल की संरचना का वर्णन करने के लिए पृथ्वी के चारों ओर घूमने वाले ग्रहों की संख्या को ही ध्यान रखना है। सूर्य के चारों ओर घूमने वाले ग्रहों की संख्या को ही ध्यान रखना है।

पृथ्वी के चारों ओर घूमने के कारण सभी ग्रहों को अपने-अपने अकारण को ही ध्यान रखना है। सूर्य के चारों ओर घूमने वाले ग्रहों की संख्या को ही ध्यान रखना है।



अंतरिक्ष यानों के संचालन के लिए सौरमण्डल की संरचना का वर्णन करने के लिए पृथ्वी के चारों ओर घूमने वाले ग्रहों की संख्या को ही ध्यान रखना है।

पृथ्वी के चारों ओर घूमने के कारण सभी ग्रहों की संख्या को ही ध्यान रखना है।

सौरमण्डल का अर्थ (पृथ्वी) ज्ञात करने के लिए पृथ्वी के चारों ओर घूमने वाले ग्रहों की संख्या को ही ध्यान रखना है।

पृथ्वी का अकारण रूप है।

अर्थ में ही सौरमण्डल का अर्थ है। सौरमण्डल का अर्थ है।

पृथ्वी के चारों ओर घूमने के कारण सभी ग्रहों की संख्या को ही ध्यान रखना है।

सौरमण्डल का अर्थ है। सौरमण्डल का अर्थ है।

## ॥ सप्ताह के सात दिन ॥

सौरमण्डल की संरचना का वर्णन करने के लिए पृथ्वी के चारों ओर घूमने वाले ग्रहों की संख्या को ही ध्यान रखना है।

सौरमण्डल की संरचना का वर्णन करने के लिए पृथ्वी के चारों ओर घूमने वाले ग्रहों की संख्या को ही ध्यान रखना है।

सौरमण्डल की संरचना का वर्णन करने के लिए पृथ्वी के चारों ओर घूमने वाले ग्रहों की संख्या को ही ध्यान रखना है।

- रविवार
- सोमवार
- मंगलवार
- बुधवार
- गुरुवार
- शुक्रवार
- शनिवार



सौरमण्डल की संरचना का वर्णन करने के लिए पृथ्वी के चारों ओर घूमने वाले ग्रहों की संख्या को ही ध्यान रखना है।

## ॥ गुरुत्वाकर्षण सिद्धांत ॥

सौरमण्डल की संरचना का वर्णन करने के लिए पृथ्वी के चारों ओर घूमने वाले ग्रहों की संख्या को ही ध्यान रखना है।

सौरमण्डल की संरचना का वर्णन करने के लिए पृथ्वी के चारों ओर घूमने वाले ग्रहों की संख्या को ही ध्यान रखना है।



सौरमण्डल की संरचना का वर्णन करने के लिए पृथ्वी के चारों ओर घूमने वाले ग्रहों की संख्या को ही ध्यान रखना है।

सौरमण्डल की संरचना का वर्णन करने के लिए पृथ्वी के चारों ओर घूमने वाले ग्रहों की संख्या को ही ध्यान रखना है।

सौरमण्डल की संरचना का वर्णन करने के लिए पृथ्वी के चारों ओर घूमने वाले ग्रहों की संख्या को ही ध्यान रखना है।

सौरमण्डल की संरचना का वर्णन करने के लिए पृथ्वी के चारों ओर घूमने वाले ग्रहों की संख्या को ही ध्यान रखना है।

## ॥ त्रिकोणमिति ॥ Trigonometry

त्रिकोणमिति का आविष्कार एवं प्रयोग प्राचीन भारत में किया गया। भारतीय 'गणित' और 'कोटिगणित' की यूरोपीय भाषाओं में साइन Sine और कोसाइन Cosine बन गए।



अर्थ में ही सौरमण्डल का अर्थ है। सौरमण्डल का अर्थ है।

सौरमण्डल की संरचना का वर्णन करने के लिए पृथ्वी के चारों ओर घूमने वाले ग्रहों की संख्या को ही ध्यान रखना है।



## RISHI KAṆĀDA - WATER CYCLE

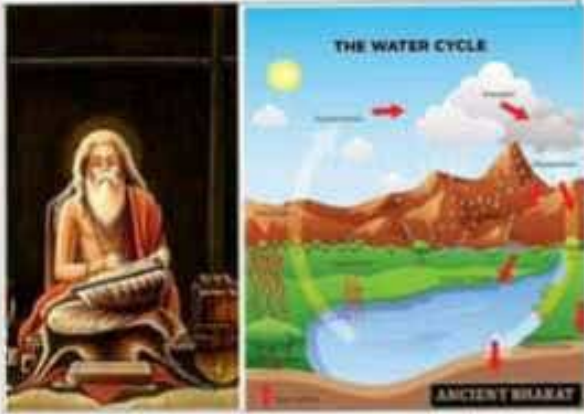

Four thousand years ago, Rishi Kaṇāda discussed water cycle in exactly the same way in which NASA and other scientists discuss today. The amazing point is, Kaṇāda mentions evaporation, transpiration, condensation, precipitation and collection systematically, just in four sutras.



नास्ति मूलम् अनौषधम्

## Everything as Medicine

In the ancient university of Takshashila, there was a student of medicine named Jeevaka. A brilliant student, he easily outshone his peers. After 12 years of study, the master Bhikshu Atreya said, "Today you have a test. I want you to find within one yojana (13 km) radius of Takshashila, an object which has no medicinal properties."

Dr. J. K. Chakravarti

## Did You Know?



The First One who worked on Language grammar was MAHARISHI PANINI in the book अष्टाध्यायी (Aṣṭādhyāyī). There are thousands of Sutras in Ashtadhyayi and not even a single letter is extra. West Gave all credit to "Lindley Murray's"

## Did you know ?



when the rest of the world did not even know how to write then gurukul was in India used to teach. Gurukul are mostly under trees where availability of oxygen is more and students can have more focus in learning.

## Electric battery used in Ancient India around 4000 years ago

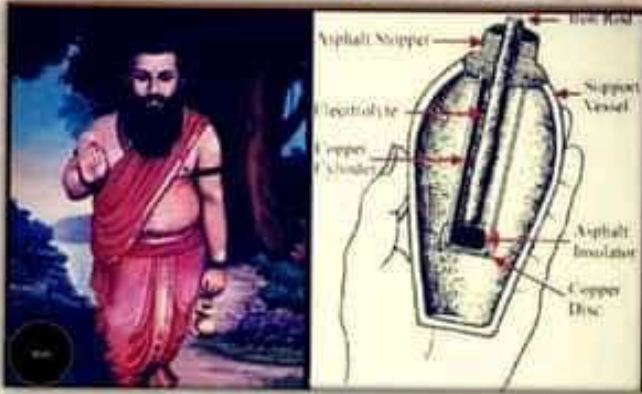

Remember, we read in history books that the electric battery was created by a man called Alessandro Volta just 200 years ago, but sage Agastya used this battery at least 4000 years ago. But what's really strange is that Alessandro Volta uses pretty much the same materials for creating the "veryfirst battery".

## Concept of Multiverse in Sanatan Dharm



क्षित्यादिभिरेष किलावृतः सप्तभिर्दशगुणोत्तरैरण्डकोशः ।  
 यत्र पतत्यणुकल्पः सहाण्डकोटिकोटिभिस्तदनन्तः ॥३७  
 Every universe is covered by seven layers – earth, water, fire, air, sky, the total energy and false ego – each ten times greater than the previous one.

## DID YOU KNOW?



SPIRITUALITY DECODED

### RISHI AGASTYA- THE GREAT SIDDHA RISHI

Agastya or Agathiyar was the first and foremost Siddha of the Siddha tradition. He taught Sri Rama Aditya hridayam. He gave Sri Rama his bow, two inexhaustible arrow quivers, a sword. He has saved devas on various occasions!. He is the author of Agastya Samhita which talks about battery and electricity thousands of years ago. Lord Shiva taught the Siddhas tradition to Murugan or Karthikeya and Murugan taught this to Agastya. Rishi Agastya literally drank all water in the ocean with the help of his siddhis or power of his tapas!.

## Agastya Samshita



In the Prince's Library of Ujjain in India, there is a well preserved document called the 'Agastya Samshita', which dates back to the first millennium BC. It contains a detailed description not only of how to construct an electric battery/cell, but also, how to utilize the battery to 'split' water into its constituent gasses.

# INDIAN INVENTIONS

## SUŚRUTA SAMHITA CURE FOR LEPROSY



- Kearns & Nash (2008) state that the first mention of leprosy is described in the Indian medical treatise Sushruta Samhita (6<sup>th</sup> century BCE).
- However, The Oxford Illustrated Companion to Medicine holds that the mention of leprosy, as well as ritualistic cures for it, were described in the Atharva-veda (1500–1200 BCE), written before the Sushruta Samhita.

## SNAKES AND LADDERS

- Inspired from an Indian game called Mokshapat
- During British rule of India, this game made its way to England, & was introduced in the USA in 1943.

## TRIGONOMETRIC FUNCTIONS



- The trigonometric functions sine and versine originated in Indian astronomy.
- Described in detail by Aryabhata in the late 5<sup>th</sup> Century
- In 6<sup>th</sup> C. astronomer Varahamihira discovered a few basic trigonometric formulas or identities, such as  $\sin^2(x) + \cos^2(x) = 1$ .

# MOKSHA PATAMU POPULARLY KNOWN AS SNAKE AND LADDER

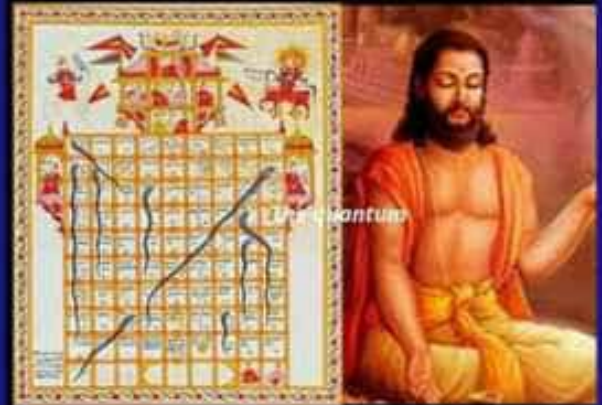

WAS INVENTED BY RISHI  
GYANDEV. 13TH CENTURY AD

## Did you know?

It was an Indian scientist  
Maharishi Kanada who discovered  
'Atomic Theory', described  
dimensions & motion 2600 years ago

ANCIENT BHARAT



But only name we know is  
England's John Dalton's who didn't  
Give 'Atomic Theory' until 1803.  
This is not anyone's fault.  
Rather this is what our syllabus  
Taught us

## DID YOU KNOW?

**PYTHAGORAS THEOREM  
WAS KNOWN IN INDIA  
IN 800 BC!**



### Baudhayana sutra

दीर्घपतुरभ्यस्यत्स्रया रज्जुः पार्श्वस्यो दीर्घं ततो च वात् पृथक् शतौ  
कुसरात्पुत्रं करोति ३

Translation:

A rope stretched along  
the length of the  
diagonal produces  
an area which the  
vertical and horizontal sides make together.



**THIS WAS 300 YEARS  
BEFORE PYTHAGORAS  
WAS BORN!**



COMING SOON

# The Lost Legacy of Vedic Geometry

Yajur Vedam holds some of the world's oldest geometrical formulas that are even used today, yet we barely hear about it.

We are turning the hidden pages of the history. Our fact-based documentary will be soon released on this, follow us on...

 /ProjectShivoham



PROJECT  
SHIVOHAM

# Ancient Indian Roots of CHESS

Chess originated in India as 'Chaturanga', travelled to Persia as 'Shatranj' & eventually to Europe as 'Chess'. Earliest records of Chess are in Gupta Empire of 600 CE. But the written records of Chess are much deeper...

अक्षौहिण्याः परीमाणं नराश्वरथदन्तिनाम्

- Aadi Parvam, Mahaabharatam

Mahabharata happened during ~3000 BCE elaborating the Ancient Indian warfare describes a classic military battalion as **AKSHAUHINI** – which is a group of **नर** (Foot Soldiers), **अश्व** (Horses), **रथ** (Chariots) & **दन्त** (Elephants), which are the **4 limbs** of a military battalion during war, also known as Chaturanga and is the source of Chess today.



Mahabharata gives precise count of each Akshauhini as 109,350 Foot Soldiers, 65,610 Horses, 21,870 Chariots & 21,870 Elephants.



PROJECT  
SHIVOHAM

# Srinivasa Ramanujan

The Man who wrote poetry about Infinity



As Nikola Tesla said, **Universe and everything in it, is written in the language of Energy & Frequency.** Everything in this Universe always has a pattern – just that its often not easily visible, unless you see it with **the lens of Mathematics.**

Srinivasa Ramanujan – an Indian Mathematician, a born genius who contributed with his inventions on working with **Infinite Series.** In simple words, **every scientific research often involves in decoding the hidden patterns** – be it the DNA of a Pathogen or understanding energy shifts in the Cosmos. Ramanujan's inventions contributed heavily to such scientific researches.

Ramanujan had **a mysterious condition.** All the formulae for different mathematical problems just used to come to his mind intuitively, which eventually are **all proven to be right!** Even on his deathbed, during his last days, he wrote 600 such mathematical formulae which scientists are now using to understand the entropy & behaviour of **Black holes in the Universe.** Ramanujan didn't just knew Infinity, but he wrote a poetry about it!



PROJECT  
**SHIVOHAM**

# Formula for Area of a Triangle as per Yajur Vedam

दीर्घचतुरश्रस्याक्षणया रज्जुः पार्श्वमानी तिर्यग्  
मानी च यत् पृथग् भूते कुरुतस्तदुभयं करोति॥

- Baudhāyana Sulba Sūtra, Yajur Vedam

*"A rope stretched along the length of the diagonal produces an area which the vertical and horizontal sides make together"*

$$C^2 = A^2 + B^2$$

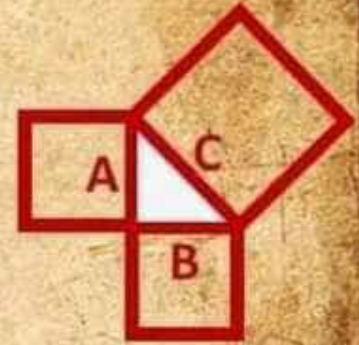

This is Baudhayana Sulba Sutra in Yajur Vedam, defining how to calculate **Area of a Triangle**. In today's world this is called Pythagoras Theorem given by Pythagoras in 500BCE but this method is widely popular in India since thousands of years and is as old as **Yajur Vedam** itself.

This formula is used in constructing Yagna Vedi in the shape of an Eagle with **TRIANGULAR TILES** in a special type of Yagna called **AGNICAYANA**.



Process of building Agnicayana Vedi and using Triangular Tiles



PROJECT  
**SHIVOHAM**



# Aryabhata's Formulas

1511 Years Old Equations for Speed, Distance & Time

Aryabhata, an Indian Astronomer & Mathematician wrote a book on Astronomy called **Aryabhatiyam** in the year 510 CE.

In this book he gave formulas for calculating radius of planets, their orbits, speed of revolutions etc. As part of it, he gave **formulas for calculating Speed, Distance & Time of Moving Bodies.**

## MEETING OF TWO MOVING BODIES

भक्ते विलोमविवरे गतियोगेनानुलोमविवरे द्वौ ।  
गत्यन्तरेण लब्धौ द्वियोगकालावतीतैष्यौ ॥ ३१ ॥

Divide the distance between the two bodies moving in the opposite directions by the sum of their speeds, and the distance between the two bodies moving in the same direction by the difference of their speeds; the two quotients will give the time elapsed since the two bodies met or to elapse before they will meet.<sup>3</sup> Reference: 31<sup>st</sup> Slokam, Chapter 2, Aryabhattiya

Given above is a verse from Aryabhatiyam for the formula of **SPEED = DISTANCE/TIME**. This equation is the foundational backbone for Kinematics - a branch of Physics.

**Galileo Galilei** - Italian Physicist re-invented this in ~1600 CE. Both Galileo & Aryabhata deserves **equal recognition & respect.**



PROJECT  
**SHIVOHAM**

# 800 Years old Architectural Marvel with Physics of Light's Diffraction

Sri Chaya Someshwar Temple in Telangana, has a **mysterious shadow** casted on the Shiva Lingam **without any visible object** standing opposite to the shadow.

This is not magic but a marvel of the temple's **meticulous architecture**. The architect of this temple created this long mysterious shadow using the principles of the **LIGHT's DIFFRACTION**.



When light hits an opaque object, it bends and creates a blur edged shadow – this blur effect is called Diffraction. Using this effect, **4 stone pillars** are placed **unnoticeably far**, outside the temple such that their 4 shadows converge to make **one single shadow** inside the temple.

As per documented history, Light's Diffraction is discovered by an Italian Physicist Francesco Grimaldi in the 1600s. But according to Archaeological Survey of India, this temple was built in 1100s. This, **indisputably** establishes that Ancient Indians mastered the Physics of Light long before the world knew what's Diffraction.



PROJECT  
**SHIVOHAM**

# Madhava Namputiri

The Man who disrupted Calculus

Madhava Namputiri is an Indian Mathematician & Astronomer during 13<sup>th</sup> Century from Kerala. His contributions to the field of Calculus are highly disruptive and revered even today. Back then, Kerala was the Spice hub for the trade into Europe and potentially there was a flow of knowledge from India to Europe.



Madhava  
(1340-1425)

Later in 17<sup>th</sup> Century, Sir Issac Newton and Gottfried Leibniz further developed Calculus. Even

today, in the honour of Madhava, in the field of Calculus, his models are named as MADHAVA SERIES.

Calculus is a branch of Mathematics that deals with predicting the outcome of a simulation in various fields right from Economics, Biology, up until launching Satellites & Space Travel. Madhava's works are the basis for predictive analysis even today.

As an Astronomer, he also invented mathematical models to calculate the position of Moon accurately for every 36 minutes. He was also the 1<sup>st</sup> to calculate the value of Pi as 3.1415926535922 which is very close to 3.141592653589793, the value used in space expeditions today. He gave the formula for Pi in the form of below slokam in the book Kriya Kramakari.

व्यासे वारिधिनिहते रूपहते व्याससागराभिहते ।  
त्रिशरादिविषमसङ्ख्याभक्तमृणं स्वं पृथक् क्रमात् कुर्यात् ॥

$$\pi = 4 \left( 1 - \frac{1}{3} + \frac{1}{5} - \frac{1}{7} + \dots \right)$$



PROJECT  
SHIVOHAM

# Gravity in Ancient India

गगनमुपैति शिखिशिखा क्षिप्तमपि क्षितिमुपैति गुरु किञ्चित् ।  
यद्वदिह मानवानामसुराणां तद्वदेवाधः ॥

- 4<sup>th</sup> Slokam , 13<sup>th</sup> Chapter, Pancha Sidhantika

Ancient India was the Powerhouse of Astronomy, Mathematics & many other fields of Science.

Above slokam describes that "Any Heavy (गुरु) Object if thrown above towards the sky, falls back to the ground."

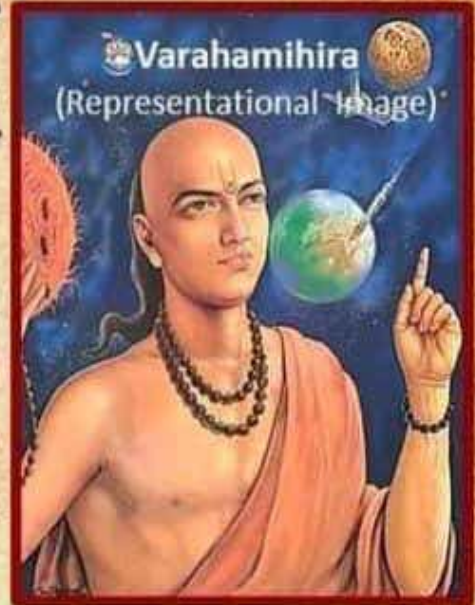

It describes the phenomenon of **GRAVITY**. 'Gravity' comes from Latin word **GRAVIS**, which is cognate to Sanskrit word **GURU**, which means 'Heaviness' or 'Mass-fullness'.

Above slokam is from **Pancha Sidhantika** written by **Varahamihira** in 575 CE. Even other Indian Astronomers of 5<sup>th</sup>-6<sup>th</sup> CE like **Aryabhatta** & **Brahmagupta** mathematically described Gravity at length; more than 1000 years before **Sir Issac Newton** rediscovered the concept of Gravity.

Most unfortunately, even the names of these Great Indian Astronomers are not known to the Indians today !



PROJECT  
**SHIVOHAM**

# Surya Siddhantam

## & the science behind Weekdays

Why ONLY 7 days in a week? If names of a week are attributed to the Planets, why Sunday and Monday are attributed to Sun & Moon which are NOT planets? What's the reason behind the SEQUENCE of the days as we use today? Gregorian Calendar today, simply has no scientific reasoning or answers!

### Order of Increasing Orbital Velocity



The answers are in Surya Siddhantam. The 7 sacred planets in Hinduism are arranged in order of increasing Orbital velocity for hourly computation. This cycle is repeated with 24-hour period to match EARTH'S ROTATION. 1<sup>st</sup> Planet of each 24-hour period is taken as the name of the day.

24 hours of Saturday starting with Saturn, in GREEN

SA	JU	MA	SU	VE	ME	MO	SA	JU	MA
SU	VE	ME	MO	SA	JU	MA	SU	VE	ME
MO	SA	JU	MA	SU	VE	ME	MO	SA	JU

25<sup>th</sup> hour starts with Sun, hence SUNDAY & so on...

Gregorian Calendar is a distorted adoption of Surya Sidhantam & hence lacks proper explanation of the above questions. The concept of Navagrahas in Hinduism is not Mythology, its simple Mathematics!



PROJECT  
SHIVOHAM

दुनिया में जितनी भी खोजें हैं वो हमारे ऋषि-मुनियों ने की हैं जो आज के वैज्ञानिक की कल्पना से परे हैं।



भास्कराचार्य  
गुरुत्वाकर्षण



आचार्य कणाद  
अणु परमाणु



ऋषि विश्वामित्र  
मिसाइल



ऋषि भारद्वाज  
वायुयान



गर्गमुनि  
नक्षत्रों



आचार्य चरक  
शरीरविज्ञान, गर्भविज्ञान,  
औषधि विज्ञान



बौद्धयन  
त्रिकोणमितिय रचना

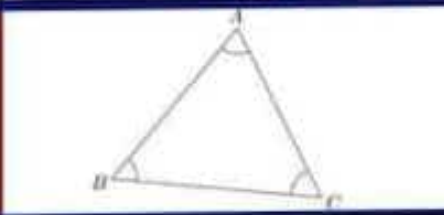

कपिल मुनि  
सांख्य दर्शन

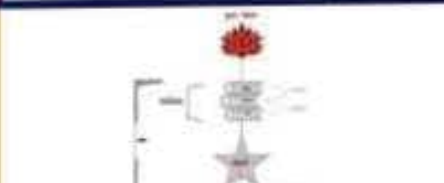

# ParmesVara- The Mathematician And Astronomer Who Gave The Radius Of Circle 350 Years Before Luhlilier

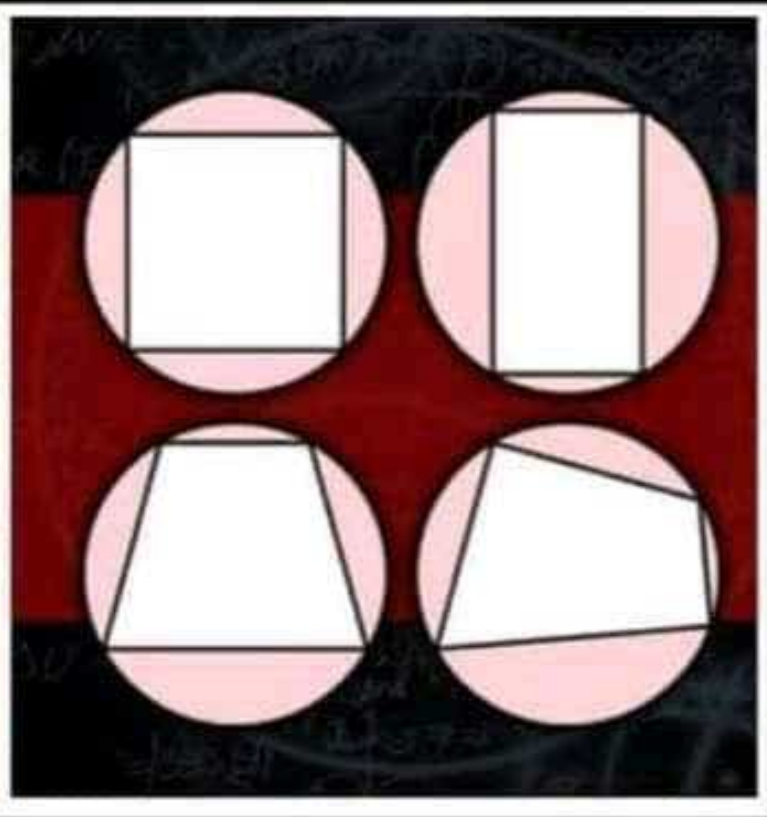

The expression for the radius of the circle in which a cyclic quadrilateral is inscribed, given in terms of the sides of the quadrilateral, is usually attributed to Simon Antoine Jean L'Huilier in 1782. However, Paramesvara described the rule 350 years earlier. If the sides of the cyclic quadrilateral are  $a$ ,  $b$ ,  $c$  and  $d$  then the radius  $r$  of the circumscribed circle was given by Paramesvara

# Atmospheric Refraction and Mirages cause Two Sunsets in Kurukshetra War. 🙏 ॐ 🚩 🏠

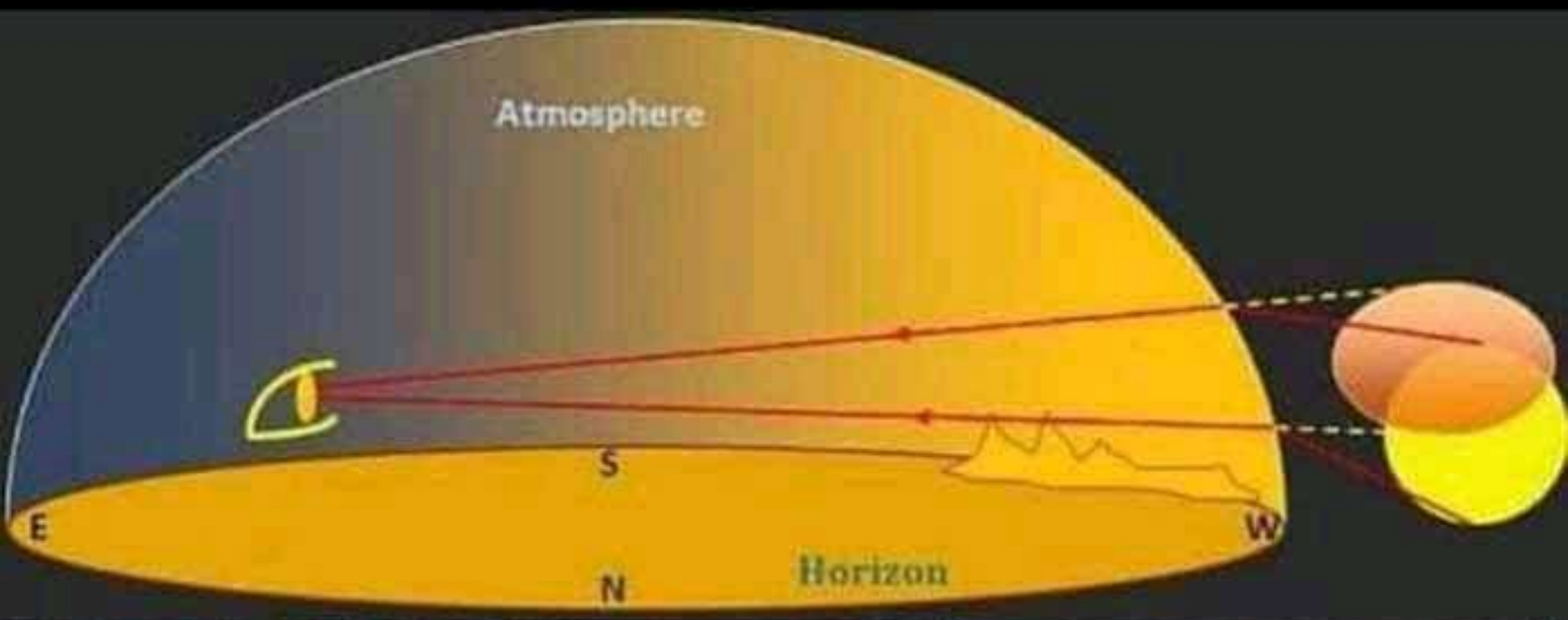



# Our ancestors were expert 🔥🔥 Engineers, read complete article



Clear upside down (inverted) image with a small pinhole

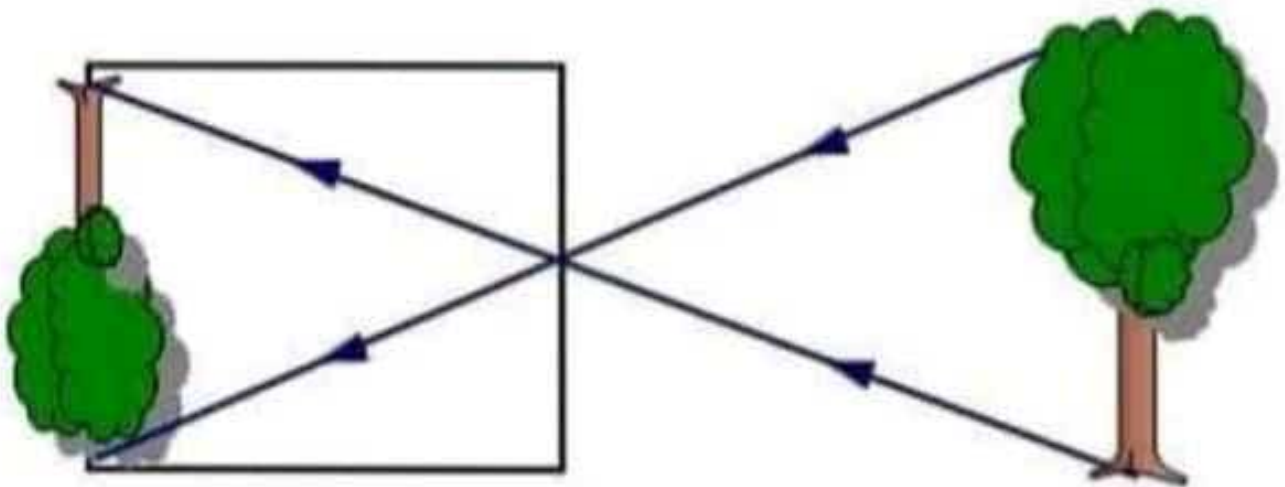

Camera closer to the object – a larger image

# Why Indian Scientists Disprove Ancient Indian Knowledge While West Praise Our Rishis



Those who looked down upon the ancient scientific achievements are not aware of even 1% of the vast repository of the ancient literature.

Is disproving anything Indian without deeper studies not unscientific?

दुनिया में जितनी भी खोजे हैं वो हमारे ऋषि-मुनियों ने की हैं जो आज के वैज्ञानिक की कल्पना से परे हैं।



भारुकराचार्य  
गुरुत्वाकर्षण



आचार्य कणाद  
अणु परमाणु



ऋषि विश्वामित्र  
मिसाइल



ऋषि भारद्वाज  
वायुयान



गर्गमुनि  
नक्षत्राँ



आचार्य चरक  
शरीरविज्ञान, गर्भविज्ञान,  
औषधि विज्ञान



बौद्धयन  
त्रिकोणमितिय रचना



कपिल मुनि  
सांख्य दर्शन

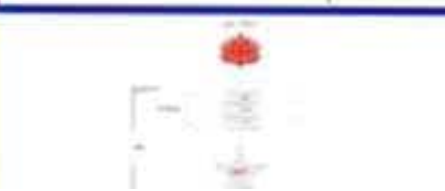

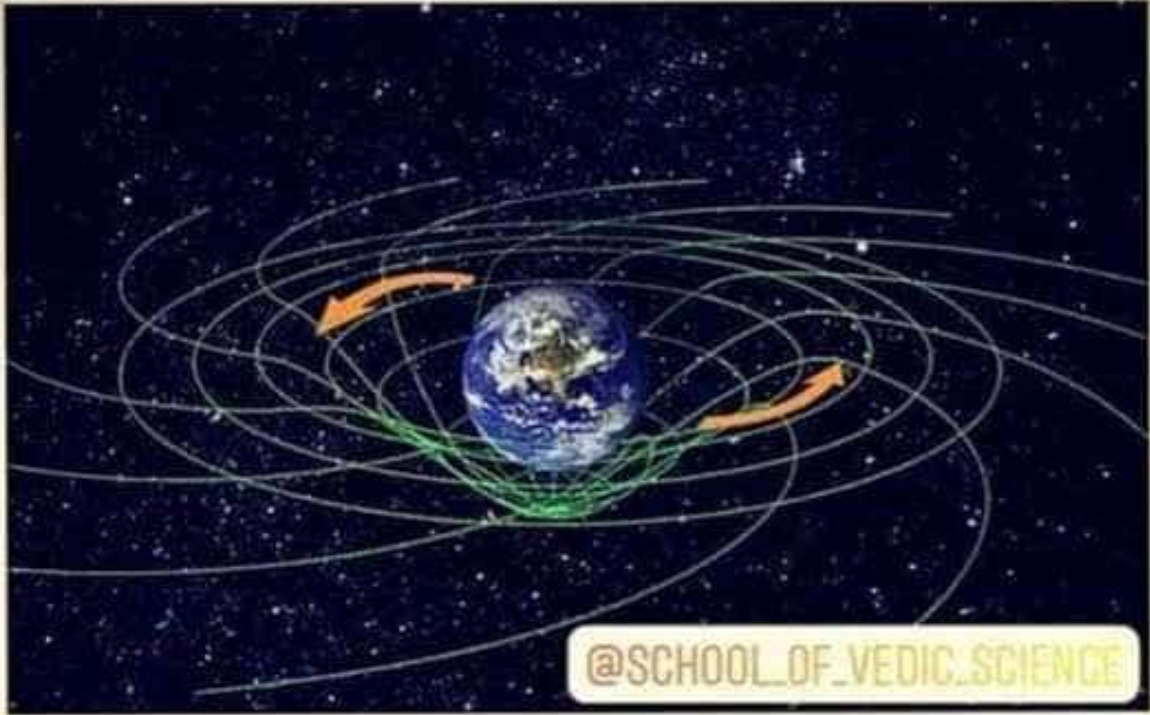

@SCHOOL\_OF\_VEDIC\_SCIENCE

## GRAVITATIONAL FORCE OR FIELD CLEARLY MENTIONED IN THE RIG VEDA

अजो न क्षां दाधारं पृथिवीं तस्तम्भं द्यां मन्त्रैभिः सत्यैः ।

प्रिया पदानि पश्वो नि पाहि विश्वारुग्ने गुहा गुहं गाः ॥ ५ ॥ ६ ॥

अजः । न । क्षाम् । दाधारं । पृथिवीम् । तस्तम्भं । द्याम् । मन्त्रैभिः । सत्यैः ।

प्रिया । पदानि । पश्वः । नि । पाहि । विश्वऽआयुः । अग्ने । गुहा । गुहम् । गाः ॥ ५ ॥ ६ ॥

**ajo naḥ kṣām dadhāra pṛthvīm tasthambha dyām**

The unborn force or field [aja] keeps us [naḥ]  
rooted to the earth [kṣām].

The same ever-present force [tat] or field holds [stambha]  
the earth [pṛthvīm] in space [dyām].

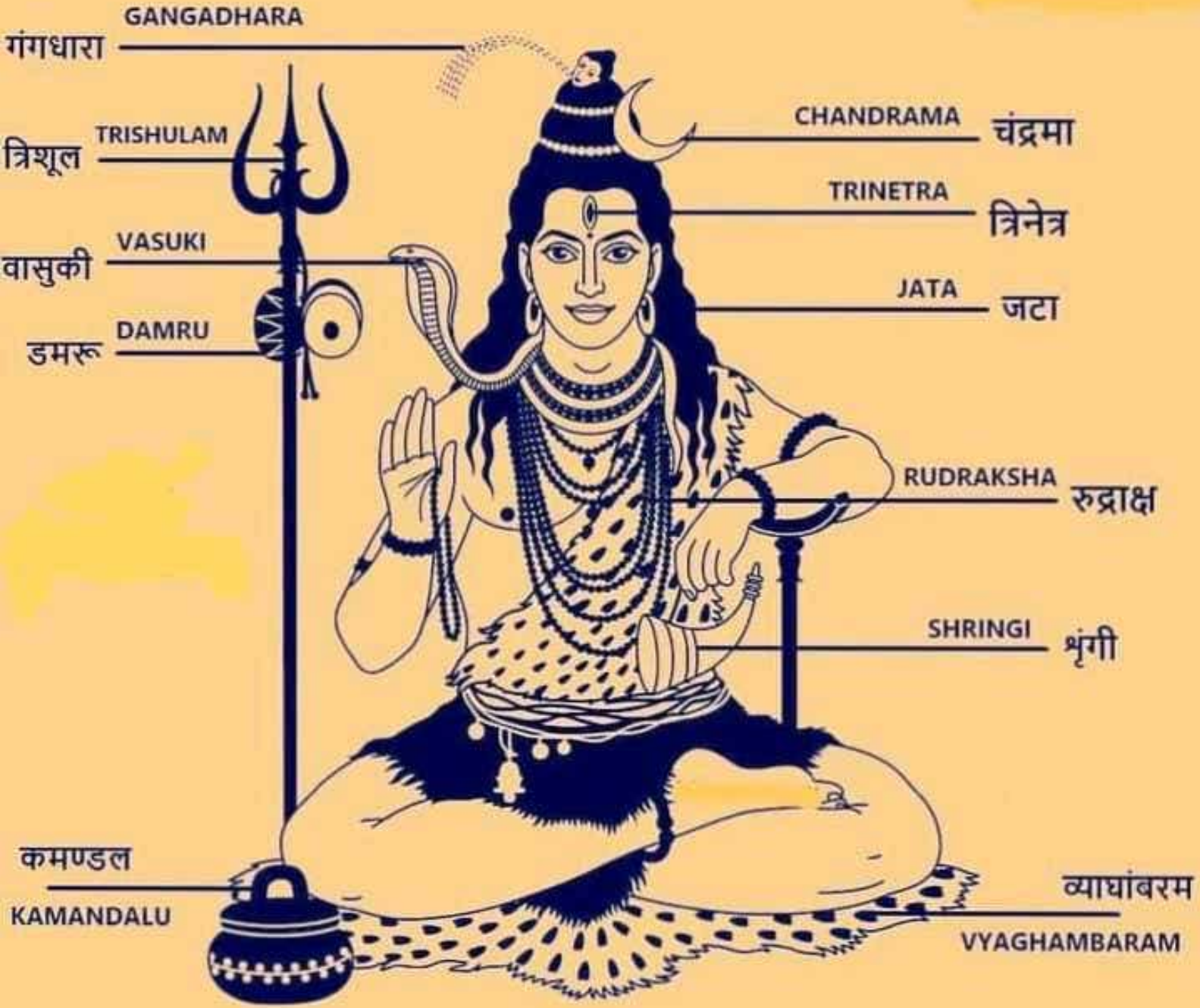

महादेव - MAHADEV

## 1 Moon

Wisdom is beyond the mind, but it needs to be expressed with a tinge of mind and this is symbolized by the crescent moon.



## 6 Bull

is a symbol of dharma (righteousness). Lord Shiva riding on the bull means that when you are truthful, the infinite consciousness is with you.

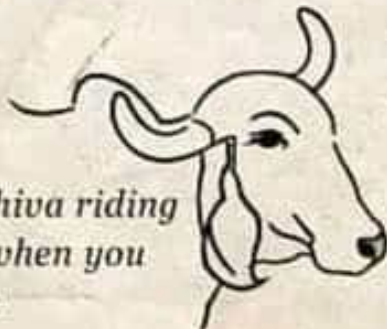

## 2 Snake

The snake symbolizes alertness. To express this state of consciousness, a snake is shown around Lord Shiva's neck.



## 3 Trident

Trishul signifies that Shiva is above all 3 states – waking, dreaming and sleeping, yet he upholds all 3 states.



## 4 Third Eye

Alertness, knowledge, and wisdom are all related to the third eye.



## 5 Drum

symbolizes the universe which is always expanding and collapsing. From an expansion it collapses and then it re-expands, this is the process of creation.



# SAPTARISHIS

-the original seekers and first scientists

## ATRI

- Seer in Vedas
- Husband of Anusuya
- Father of Dattatreya, Durvasa and Soma

## VASHISHTHA

- Owner of Kamadhenu
- Royal priest in Ayodhya
- Perceptor to Rama and Bhishma
- Yoga Vashishtha attributed to him

## KASHYAP

- Author in Rig Veda
- Husband of Diti, Aditi, Danu, Kadru, Vinata etc.
- Father to Gods, Demons, yakshas, nagas etc.

## GAUTAM

- Seer in Vedas
- Husband of Ahalya,
- Ancestor of Kripacharya
- Attributed to legends of Triyambakeswar and Godavari river

## BHARADWAJ

- Vedic Sage
- Appears in both Ramayana and Mahabharata,
- Father of sage Garga, Dronacharya, grandfather of Kubera (maternal)

## VISHWAMITRA

- Kshatriya turned Rishi, gave Gayatri Mantra
- father of Shalokuntala, grand father of Bharat (after whom the country is named)

## ANGIRAS

- Author in Rig Veda
- Father of Brihaspati and progenitor of Angiras clan, both Bharadvaj and Gautam are Angiras

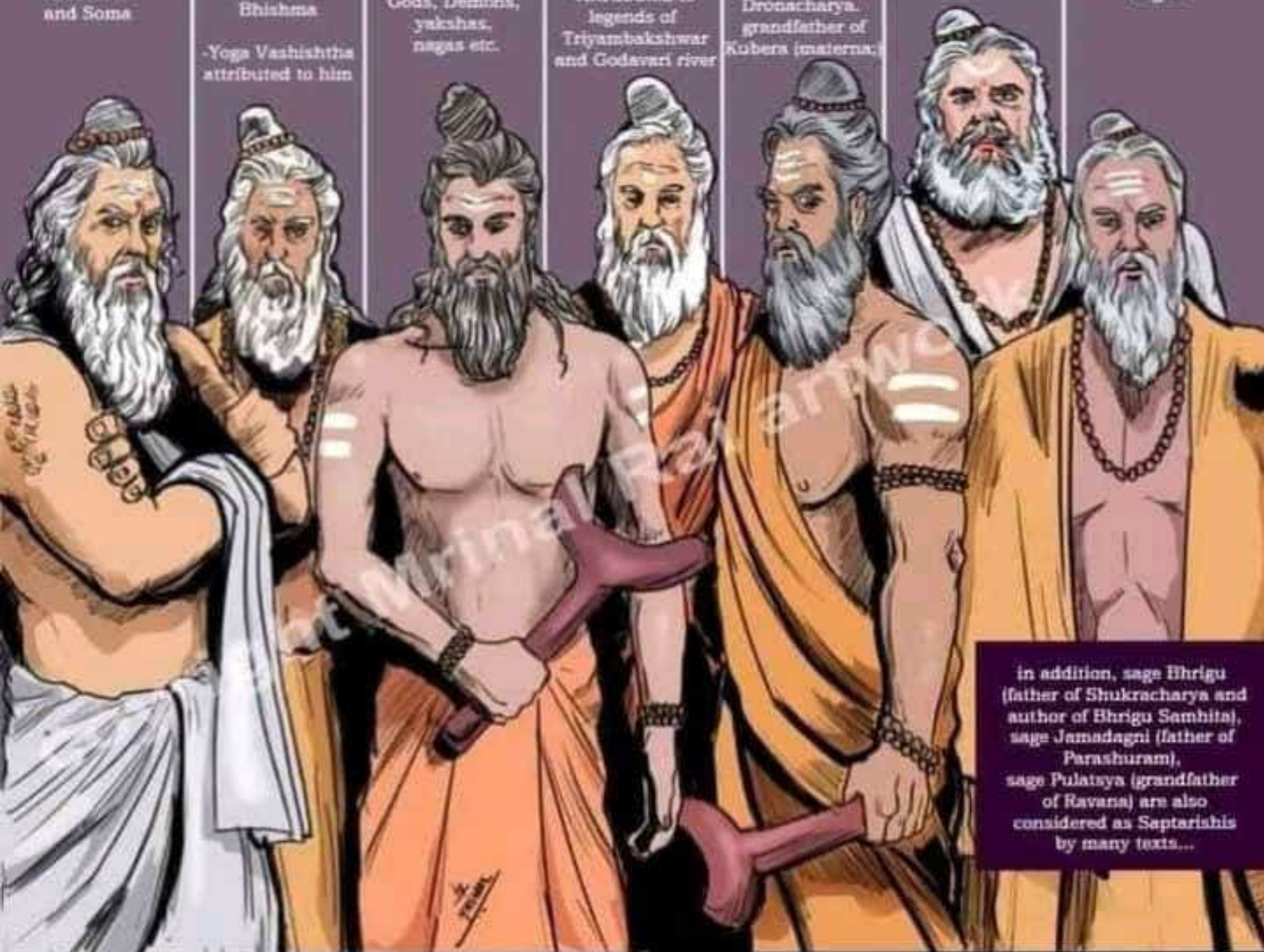

in addition, sage Bhrigu (father of Shukracharya and author of Bhrigu Samhita), sage Jamadagni (father of Parashuram), sage Pulatsya (grandfather of Ravana) are also considered as Saptarishis by many texts...

## Sage Kapil Muni: Author of the Sankhya Darshan

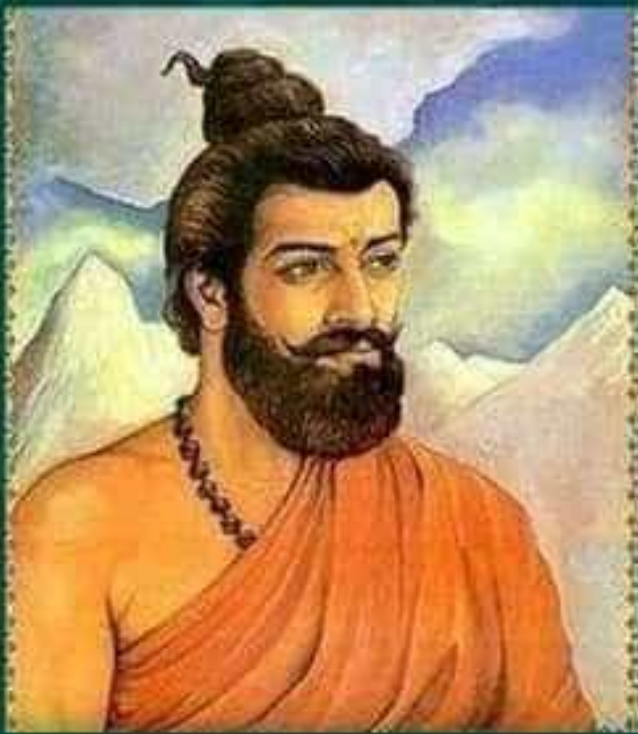

- Kapil muni was born equipped with rare intellect, dispassion and spiritual powers.
- He authored Sankhya Darshan that defined the term "Dhyaan or Meditation" as "the state of mind when remains without any subjectivity / objectivity i.e. without any thought (when the mind is away from worldly objects), is called the "Dhyaan or Meditation".
- He teaches that there is an unbroken continuity from the lowest inorganic to the highest organic forms.
- The source of world according to him is Prakriti (fundamental nature).



## Existence of Atomic and Sub atomic particles



- The world accounts discovery of atoms and sub atomic particles to Western scientists who coined these words and theories only in the early 17th century.
- An excerpt from Lalitha Sahasranama, told by Hayagreeva to Agasthya muni, dating back to the distant ages of the past, describes the Goddess as the super consciousness/Brahman that pervades even the sub atomic particles within matter.
- "Paranjyotih parandhamah paramanuh paratpara". The word "anuvu" means atom.
- Paramanu is sub-atomic particle, finer than the finest of atom, meaning electrons and the others.

# Sushruta

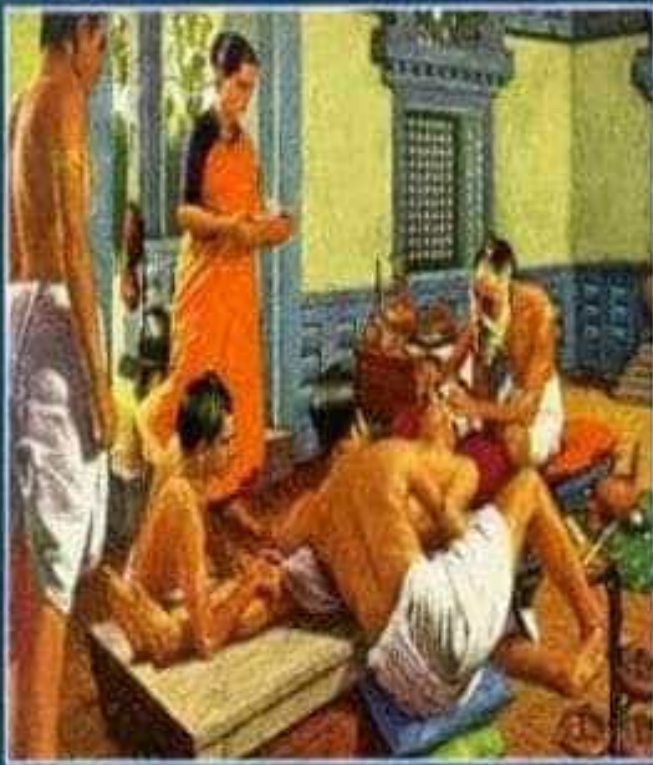

- Born to sage Vishwamitra, Sushruta is the father of surgery.
- 2600 years ago, he and health scientists of his time conducted complicated surgeries like cesareans, cataract, artificial limbs, Rhinoplasty (restoration of a damaged nose), 12 types of fractures, 6 types of dislocations, urinary stones and even plastic surgery and brain surgery.
- Usage of anesthesia was well known in ancient India.
- He is the author of the book "Sushruta Samhita", in which he describes over 300 surgical procedures and 125 surgical instruments.

## Ancient times and nuclear weapons II



- The Mahabharata clearly describes a catastrophic blast that rocked the continent.
- "A single projectile charged with all the power in the Universe...An incandescent column of smoke and flame as bright as 10,000 suns, rose in all its splendor..."
- it was an unknown weapon, an iron thunderbolt, a gigantic messenger of death which reduced to ashes an entire race."
- Historian Kisor Mohan Ganguli says that Indian sacred writings are full of such descriptions.

## Ancient times and nuclear weapons



- Radiation still so intense, the area is highly dangerous!
- A heavy layer of radioactive ash in Rajasthan, India, covers a three-square mile area, ten miles west of Jodhpur.
- For some time it has been established that there is a very high rate of birth defects and cancer in the area under construction.
- Scientists have unearthed an ancient city where evidence shows an atomic blast dating back thousands of years, from 8,000 to 12,000 years, destroying everything most of the buildings and probably a half-million people.

# Aryabhata

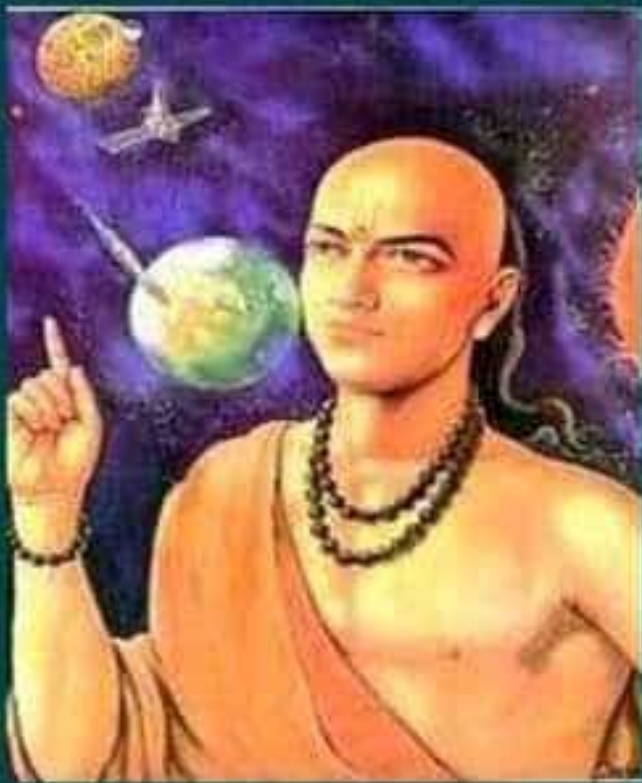

- He was a master Astronomer and Mathematician, born in 476 CE in Kusumpur (Bihar).
- In 499 CE, he wrote a text on astronomy and an unparalleled treatise on mathematics called "Aryabhatiyam"
- He formulated the process of calculating the motion of planets and the time of eclipses.
- Aryabhata was the first to proclaim that the earth is round, it rotates on its axis, orbits the sun and is suspended in space - 1,000 years before Copernicus published his heliocentric theory.

# Patanjali: The Father of Yoga

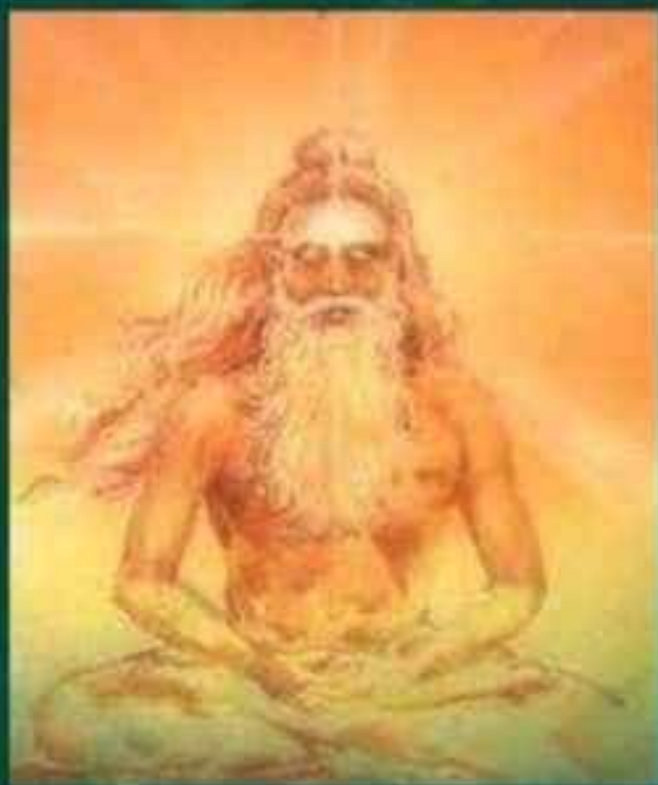

- The Science of Yoga is one of several unique contributions of India to the world.
- It seeks to discover and realize the ultimate Reality through yogic practices.
- Acharya Patanjali, prescribed the control of prana (life breath) as the means to control the body, mind and soul.
- This subsequently rewards one with good health and inner happiness.
- His 84 yogic postures effectively enhance the efficiency of the respiratory, circulatory, nervous, digestive and endocrine systems and many other organs of the body.

# Rishi Kanva



- The science of wind has been explained by Sage Kanva in Rigveda sections 8/41/6 in Jagati meter of God wind.
- Sage Kashyapa has described the features and properties of this substance in Rigveda 9/64/26 in the hymns of God Pavamana Soma in meter Gayatri.
- Kanva was a great Rishi, a descendent of Sage Angirasa.
- He looked after Shakuntala when she was abandoned by her mother and father (rishi vishwamitra). Bharat, the son of Shakuntala was also brought up by him.

# Sage Bharadwaj



- In 1875, the Vymaanika-Shaastra, a fourth century BC text written by Maharshi Bhardwaj, was discovered in a temple in India.
- The book dealt with the operation of ancient vimanas and included information on steering, precautions for long flights, protection of the airships from storms and lightning, and how to switch the drive to solar energy, or some other "free energy" source. Vimanas were said to take off vertically or dirigible.
- Bharadwaj the Wise refers to no less than 70 authorities and 10 experts of air travel in antiquity.



# Charak Samhita

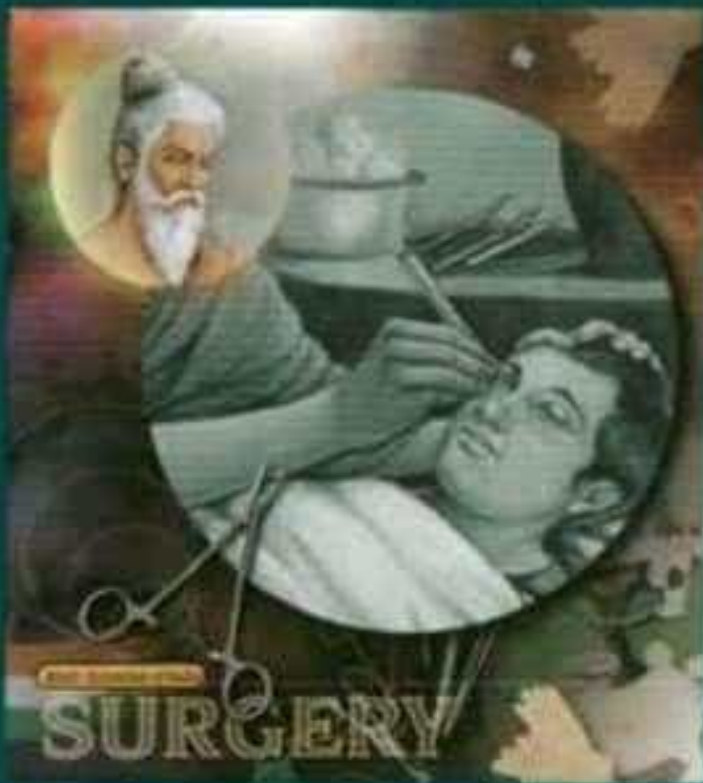

- In the "Charak Samhita" he has described the medicinal qualities and functions of 100,000 herbal plants.
- He has emphasized the influence of diet and activity on mind and body.
- He has proved the correlation of spirituality and physical health contributed greatly to diagnostic and curative sciences.
- He has also prescribed an ethical charter for medical practitioners two centuries prior to the Oath.
- Through his genius and intuition, Acharya Charak forever remains etched in the annals of history as one of the greatest and noblest of rishi-scientists.

# Acharya Charak: Father of Medicine



- Acharya Charak has been crowned as the Father of Medicine. His renowned work, the "Charak Samhita," is considered as an encyclopedia of Ayurveda.
- His principles, diagnoses, and cures retain their potency and truth even after a couple of millennium.
- When the science of anatomy was confused with different theories in Europe, Acharya Charak revealed through his innate genius and inquires the facts on human anatomy, embryology, pharmacology, blood circulation and diseases like diabetes, tuberculosis, heart disease, etc.

## Newton's Law... 1200 Years before Newton



- "Objects fall on the earth due to a force of attraction by the earth. Therefore, the earth, planets, constellations, moon and sun are held in orbit due to this attraction."
- The meaning of these lines is parallel to that of Newton's Law of Gravity.
- But these lines are not said by the European scientist. They are said by an Indian - in Surya Siddhanta, dated 400-500 AD, the ancient Hindu astronomer Bhaskaracharya states these lines.
- Approximately 1200 years later (1687 AD), Sir Isaac Newton rediscovered this phenomenon and called it the Law of Gravity.

## The Indian Sage who developed Atomic Theory 2,600 years ago II



- An interesting story states that this theory occurred to him while he was walking with food in his hand.
- As he nibbled at the food in his hand, throwing away the small particles, it occurred to him that he could not divide the food into further parts and thus the idea of a matter which cannot be divided further came into existence.
- He called that indivisible matter anu, i.e. molecule, which was misinterpreted as atom.
- He also stated that anu can have two states - Absolute rest and a State of motion.

## The Indian Sage who developed Atomic Theory 2,600 years ago

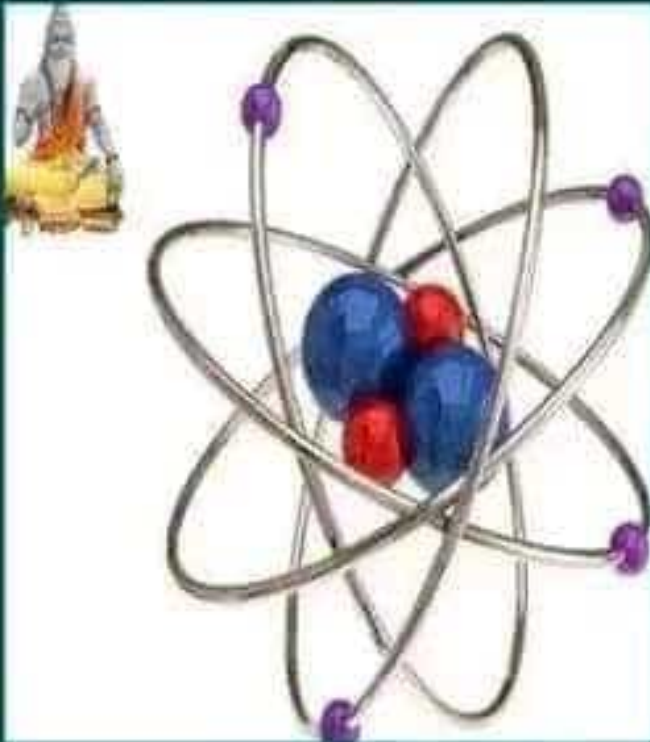

- John Dalton (1766 – 1844), an English chemist and physicist, is the man credited today with the development of atomic theory.
- However, a theory of atoms was actually formulated 2,500 years before Dalton by an Indian sage and philosopher, known as Acharya Kanad.
- Acharya Kanad was born in 600 BC in Prabhas Kshetra (near Dwaraka) in Gujarat, India. His real name was Kashyap. It was Kanada who originated the idea that anu (atom) was an indestructible particle of matter.

## The galaxy is oval, Earth is spherical



- Yajur Vedic verse: "Brahmaanda vyapta deha bhasitha himaruja..." describing Shiva as the one who is spread out in Brahmaanda.
- Anda means an egg depicting the shape of the galaxy.
- It was the middle east Europeans and Greeks who wrongly believed that earth was flat.
- But Indians, since long have always known that it was spherical.
- In many scriptures, the word Bhoogola is used, Gola meaning round.

# Varahamihira



- Varahamihir's book "panch siddhant", noted that the moon and planets are lustrous not because of their own light but due to sunlight.
- In the "Bruhad Samhita" and "Bruhad Jatak", he has revealed his discoveries in the domains of geography, constellation, science, botany and animal science.
- In his treatise on botanical science, Varahamihir presents cures for various diseases afflicting plants and trees.

# Bhaskaracharya

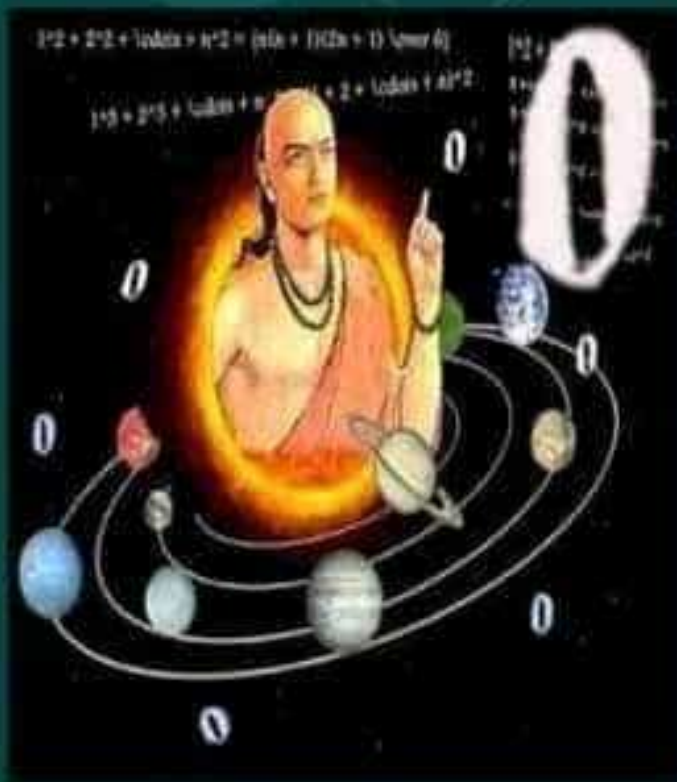

- He calculated the time taken by the earth to orbit the sun hundreds of years before the astronomer Smart;
- Time taken by earth to orbit the sun: (5th century) 365.258756484 days.
- Born in the obscure village of Vijjadit (Jalgaon) in Maharashtra, Bhaskaracharya's mathematical works called "Lilavati" and "Bijaganita" are considered to be unparalleled.
- In his treatise "Siddhant Shiromani" he writes on planetary positions, eclipses, cosmography, mathematical techniques and astronomical equipment.
- In the "Surya Siddhant" he makes a note on the force of gravity.



## Ancient science and Siddhas

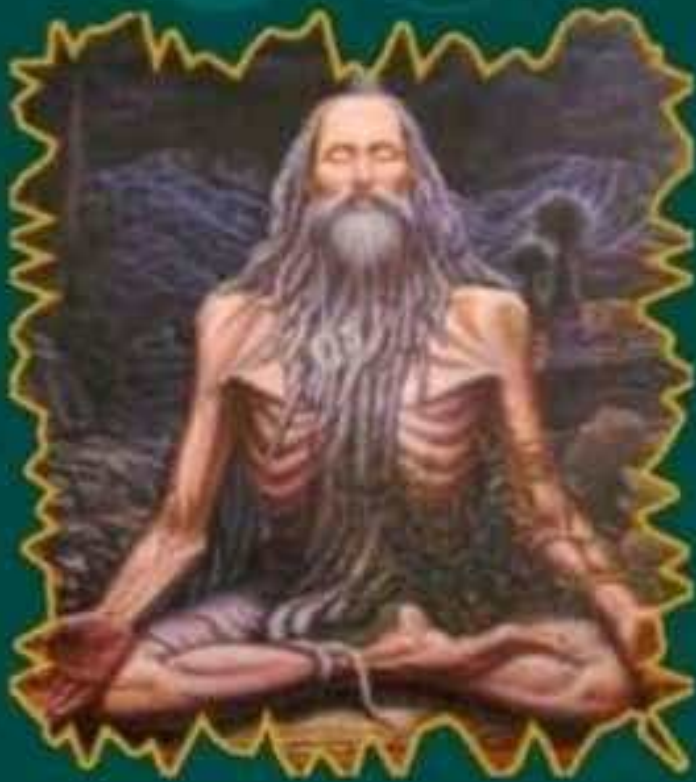

- A famous Siddha was Tirumular, who was a Tamil mystic and writer of 6th century AD and was also one of the 18 Siddhas according to the Tamil Siddha tradition.
- His main work is named "Tirumantiram", a 3,000 verse text, which is the foundation of the Southern Shaiva Siddhanta School of philosophy.
- Another Siddha, Bhogar (Bhoganathar), who lived between the 3rd and 5th century AD is said to have discovered the elixir of immortality – one his main works is the Pharmacognosy.

# Who were Siddharshi?



- There is a debate as to who was the first Siddharshi.
- Some legends talk about Sri Pathanjali, who was considered to be an incarnation of Adishesha, the celestial five-headed snake associated with God Vishnu.
- But the prevailing tradition refers to Agastya (or Agasthyar) as the first Siddharshi, one of the seven sages (or Saptarshis) as mentioned in the Vedic texts, and he was the son of the god Brahma of the Hindu creation story.

## The incredible powers of the ancient Siddharshi!

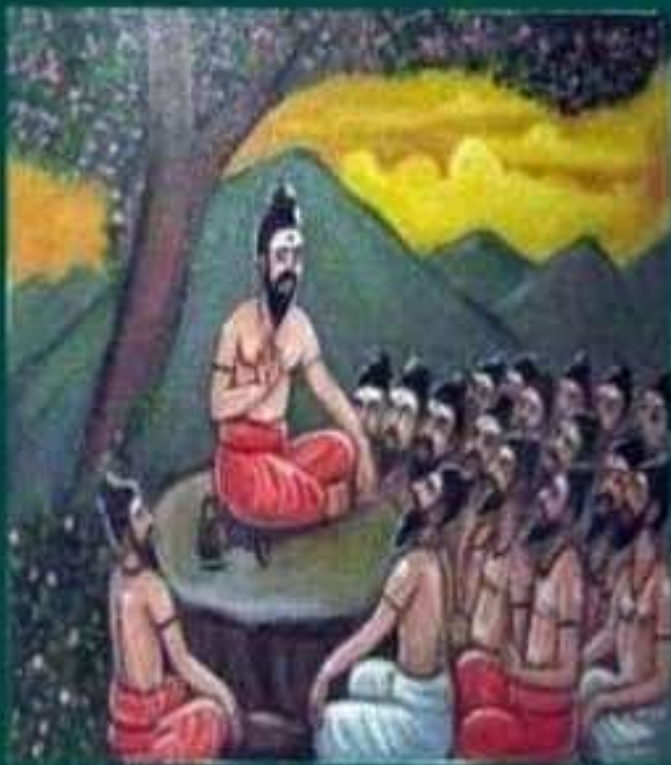

- Siddharshi are a type of saint in India who are said to have had many powers and achieved a 'god-like' state through specific secret practices that were known only to them.
- These powers spanned from controlling time and space, to transforming the body, manipulating matter at the molecular level and achieving immortality.
- The Siddharshi were followers of the God Shiva and according to different texts there were 18 of them.
- Their teachings and findings were written in the form of poems in the Tamil language.

## Ancient science knows more than modern science?



- The Vedas claim that there are living entities everywhere - even in fire.
- Modern science, however, presumed that no life could exist in fire.
- This presumption is in fact the basis for the process of sterilization.
- But recent advancements in the field of medicine have shown that microbes called 'fire bacteria' survive even in fire.

# Ancient ultrasound machines?



- Using a variety of complicated instruments, gynecologists have gradually come to know how the embryo grows during the period of pregnancy.
- But the Shrimad Bhagavatam, 3rd canto, 30th chapter, gives a vivid description of the growth of the embryo in the mother's womb.
- If we compare the information given therein with the information given in a standard textbook such as the embryology section of Gray's Anatomy, there are striking similarities in the information obtained from the two sources.

## Kapil Muni: Finding how the Universe was created



- According to Kapil Muni, there are twenty-five principles responsible for the manifestation of the Creation (Samasara), out of which Purusha and Prakriti are eternal and independent of each other.
- Kapila is not concerned to deny the reality of personal God or Maheshwara. Yet his assertion is that, no arguments can irrefutably establish God's reality.
- Therefore, in his model of creation the Purusha (Spirit) and Prakriti (matter) are held solely responsible for creation, without acknowledging an Almighty and intelligent Creator, the God.

# Ashta Siddhis of Siddhas



- The powers that the Siddhas possessed were separated in categories.
- The main category included 8 powers called ashta siddhis:
  - To become tiny as the atom within the atom (Anima);
  - To become big in unshakeable proportions (Mahima);
  - To become as light as vapour in levitation (Laghima);
  - To become as heavy as the mountain (Garima);
  - To enter into other bodies in transmigration (Prapti);
  - To be in all things, omnipervasive (Prakamya);
  - To be lord of all creation in omnipotence (Isatvam);
  - To be everywhere in omnipresence (Vasitvam)



## The Seven Sages (The Big Dipper)

These are the Sages Krishna refers to  
in "The Opulence of the Absolute 10.6" in  
the Bhagavad Gita "As It Is" text.

# SAPTARISHIS

-the original seekers and first scientists

ATRI	VASHISHTHA	KASHYAP	GAUTAM	BHARADWAJ	VISHWAMITRA	ANGIRAS
<ul style="list-style-type: none"> <li>- Seer in Vedas</li> <li>- Husband of Anusuya</li> <li>- Father of Dattatreya, Durvasa and Soma</li> </ul>	<ul style="list-style-type: none"> <li>- Owner of Kamadhenu</li> <li>- Royal priest in Ayodhya</li> <li>- Perceptor to Rama and Bhishma</li> <li>- Yoga Vashishtha attributed to him</li> </ul>	<ul style="list-style-type: none"> <li>- Author in Rig Veda</li> <li>- Husband of Diti, Aditi, Dama, Kadru, Vinata etc.</li> <li>- Father to Gods, Demons, yakshas, nagas etc.</li> </ul>	<ul style="list-style-type: none"> <li>- Seer in Vedas</li> <li>- Husband of Ahalya,</li> <li>- Ancestor of Kripacharya</li> <li>- Attributed to legends of Triyambakeswar and Godavari river</li> </ul>	<ul style="list-style-type: none"> <li>- Vedic Sage</li> <li>- Appears in both Ramayana and Mahabharata.</li> <li>- Father of sage Garga, Dronacharya, grandfather of Kubera (maternal)</li> </ul>	<ul style="list-style-type: none"> <li>- Kshatriya turned Rishi, gave Gayatri Mantra</li> <li>- father of Shakuntala, grand father of Bharat (after whom the country is named)</li> </ul>	<ul style="list-style-type: none"> <li>- Author in Rig Veda</li> <li>- Father of Brihaspati and progenitor of Angiras clan, both Bharadvaj and Gautam are Angiras</li> </ul>



# Thread Facts That They Never Taught You.

1. Father of Astronomy: Aryabhata ;  
Work - Aryabhattiyam
2. Father of Astrology: Varahamihira,  
Works; Panchasiddhantika, Bruhat  
Hora Shastra
3. Fathers of Surgery : Charaka and  
Sushruta , Works : Samhitas

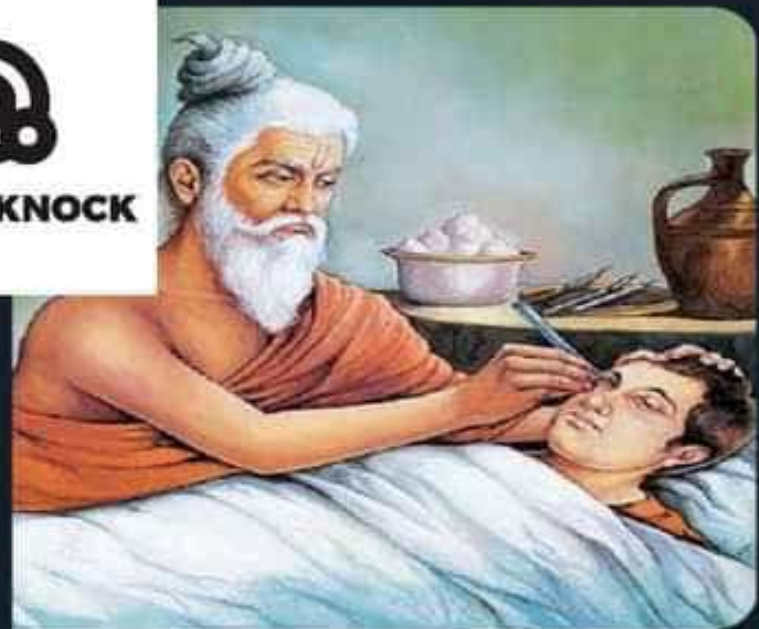
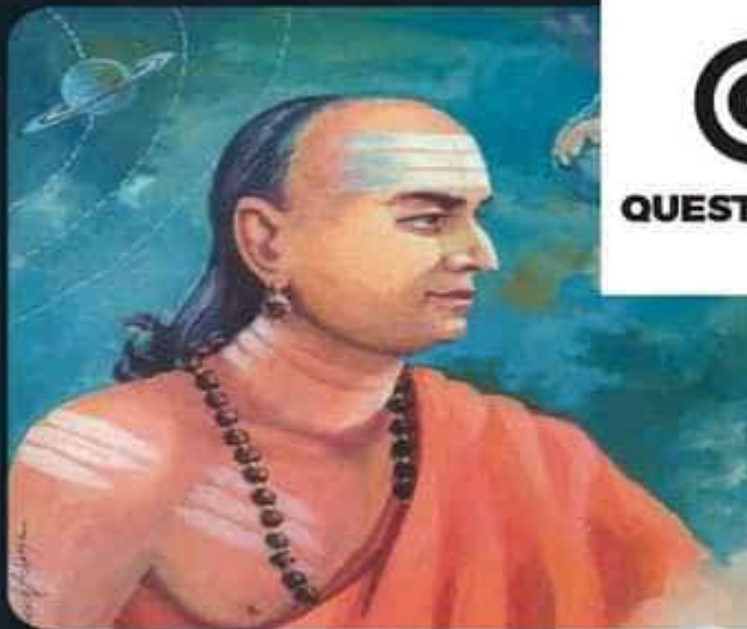

Bhagavad Gita Chapter 04, Text 13

चातुर्वर्ण्यं मया सृष्टं गुणकर्मविभागशः ।  
तस्य कर्तारमपि मां विद्ध्यकर्तारमव्ययम् ॥ १३ ॥

*cātur-varṇyam mayā sṛṣṭam guṇa-karma-vibhāgaśaḥ  
tasya kartāram api mām viddhy akartāram avyayam*

According to the three modes of material nature and the work associated with them, the four divisions of human society are created by Me. And although I am the creator of this system, you should know that I am yet the non-doer, being unchangeable.

The upper right hand is a drum whose sound is the sound of universe creation(big-bang)

The lower right hand makes the gesture of preservation



The upper left hand is a tongue of flame, a reminder of the destruction of the universe.

The lower left hand he points to his raised left foot, the place of refuge and salvation for the devotee.

There is a 2.5 m tall Nataraj statue situated at CERN, Geneva; which is the world's largest centre for scientific research. A special plaque links the Tandava dance with the energy dance of modern times. Also, all the atomic reactors in the world are in Shiv Linga Shape.

## SCIENCE AS PER INDIAN SPIRITUALITY

*Modern physics has revealed that every subatomic particle performs an energy dance; a pulsating process of creation and destruction. The entire Universe is engaged in movement in an uninterrupted cosmic dance of energy. For the modern physicists, then Shiv's dance is the dance of subatomic matter, it is a continual dance of creation and destruction involving the whole cosmos; the*

# ELECTRICITY

IN A CELL

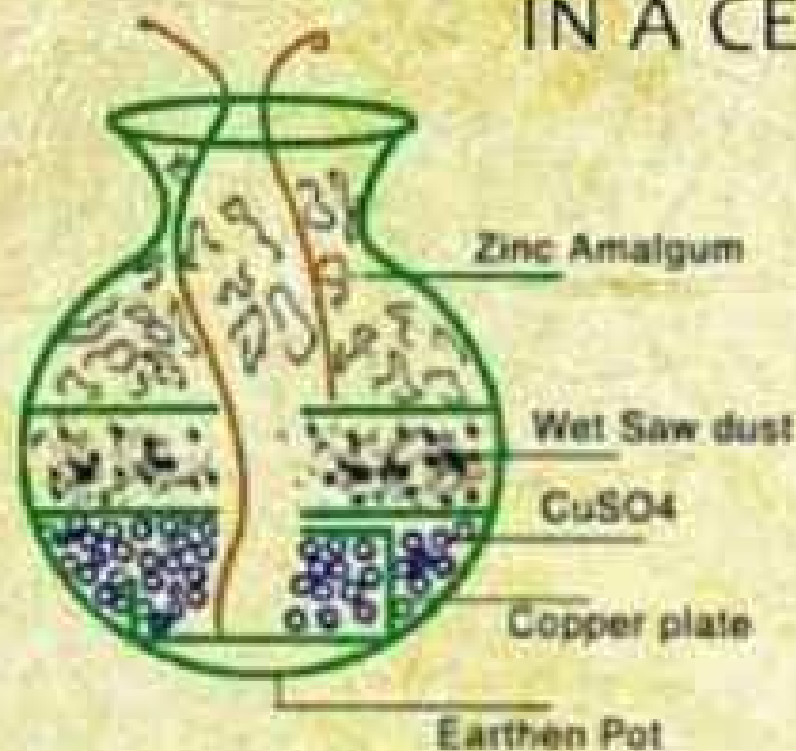

## Shloka:

Dastalosto nidhatatvah paradacchaditastatah |  
Utpadayati tanmitram samyogastamradastayoh ||

## Meaning:

Lumps of gems generate electricity by the union of copper and zinc

## Shloka:

Samyogajjayate tejo yanmitramiti kathyate |  
Evam satanam kumbhanam samyogah karyakrtsmrtah

## Meaning:

By the union, energy is born which is referred to as the sun,  
Such a union of hundred of cells is remembered as the doer

# Did you know...

[f](#) / [i](#) / heritage first



## Aryabhata had correctly estimated the circumference of earth ?

By estimating the value of pi to be **3.1416**, Aryabhata had concluded the circumference of earth to be **39736 kms**. Today, we know it to be **40,075 kms**. How cool is that!

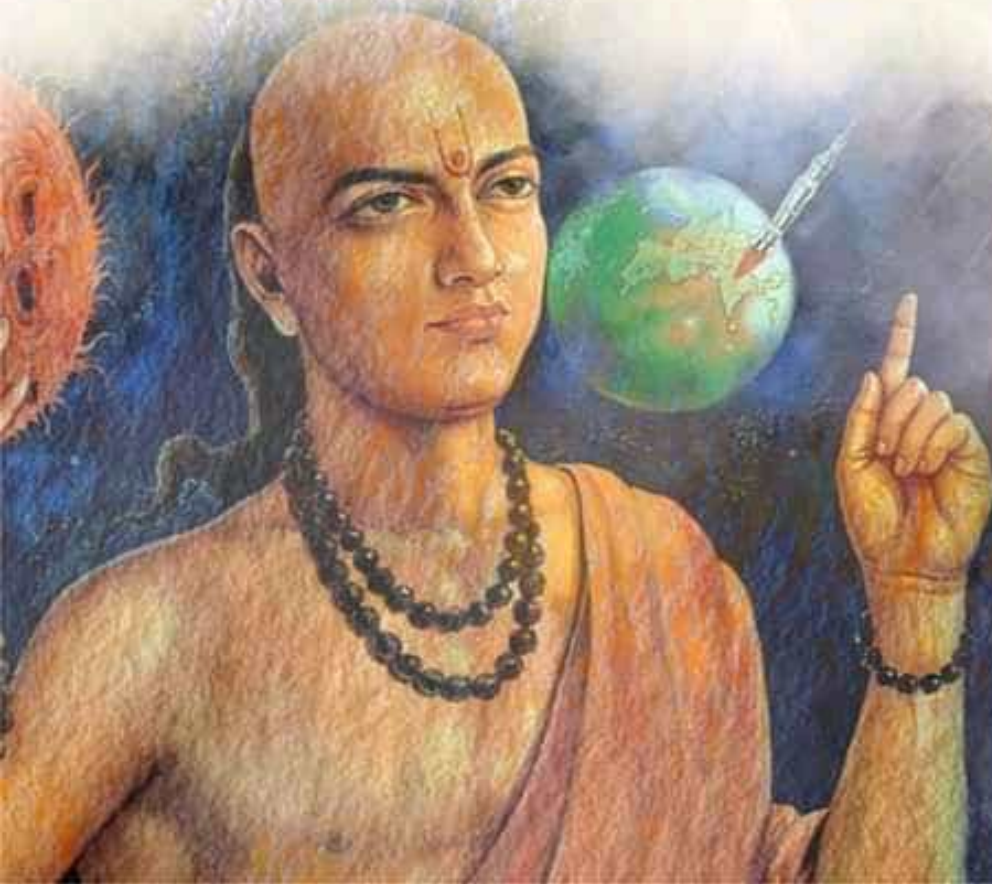

# FAST FACTS

## About Hinduism

### **Sanātana Dharma:**

Hinduism was originally known as Sanātana Dharma

### **4,000 years old:**

Hinduism is the oldest religion in the world

### **1.25 billion global followers:**

About 15.1% of the world's population are Hindus

### **No founding event:**

Hinduism has no origin or founder

### **Brahman is the Supreme Being:**

But there are 33 Million deities in Hinduism

### **The Holy Trinity:**

Brahma, Vishnu and Shiva are the 3 representations of Brahman.

### **Shakti is a Universal Force:**

Hinduism worships male and female deities equally

### **Rig Veda, the first religious Sanskrit scripture:**

The Vedas are the oldest Hindu texts

### **Samsara and Karma:**

Hinduism believes in reincarnation and the law of cause/effect

### **Buddha is an avatar of Vishnu:**

Buddhism has originated from Hinduism

### **The divine symbols:**

Om and the Swastika



why copper was used by  
our Ancestors ?



WHY COPPER  
WAS USED BY OUR  
ANCESTORS ?

@\_MeeRadha

copper can destroy undesirable virus and bacteria. Ayurveda recommends storing water into copper vessels. Ancient indians throw copper coins in rivers,lakes ,ponds and wells to destroy bacteria and virus but todays generation throws coins without knowing the actual meaning of it.



**Subramanian Swamy** ✓

@Swamy39

Manchester Univ. Confirms: This is How Isaac Newton Stole Concept of Gravity from a Hindu Gurukul [mailonnews.com/](http://mailonnews.com/)



18th Century AD

## Laws of motion

Newton vs Rishi Kanad

Thief Newton copied Rishi

Kanad's Vaisheshika Sutra as it is 6th or 2nd Century BC



1) First Law of Motion -

*Kanad* : वेगः निमित्तविशेषात् कर्मणो जायते

*Newton*: The change of motion is due to impressed force

2) Second Law of Motion -

*Kanad* : वेग निमित्तापेक्षात् कर्मणो जायते नियत्दिक् क्रिया प्रबंध हेतु

*Newton*: The change of motion is proportional to the motive force impressed and is made in the direction of the right line in which the force is impressed

3) Third Law of Motion -

*Kanad* : वेगः संयोगविशेषाविरोधी

*Newton*: To every action there is always an equal and opposite reaction



# the ayurvedic clock

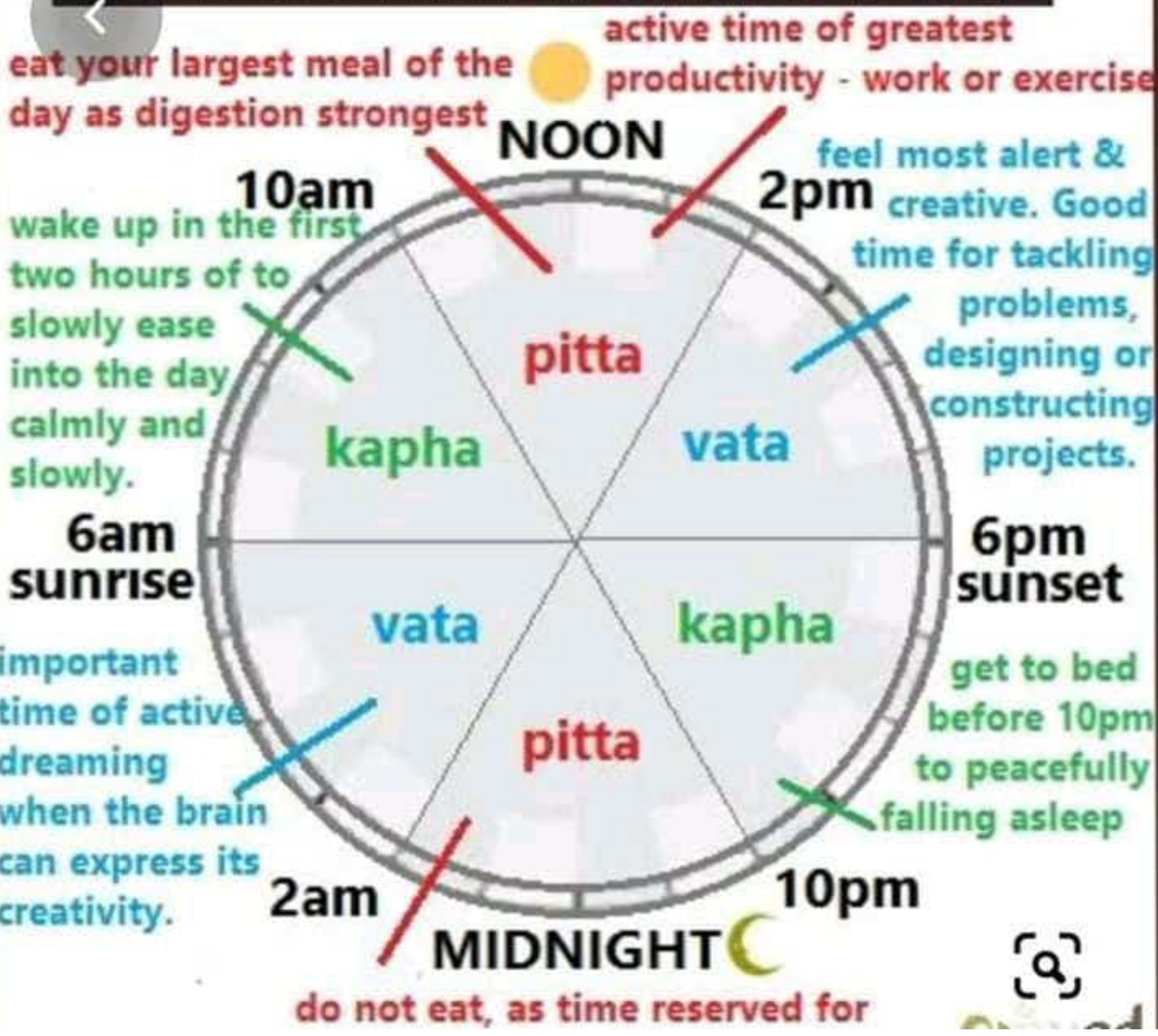

Ancient Indian scientist Nagarjuna conducted many lab experiments on metallurgy/alchemy.



He introduced gold shine mechanism now used in jewelry industry. Iranian historian Al Beruni described Nagarjuna as a 'famous representative' of Indian Alchemy.

# THE FIVE PRANA



## UDANA

PHYSICAL LOCATION- THROAT TO HEAD  
FUNCTIONS - PHYSICAL SENSES, MENTAL STRENGTH, SPEECH  
CHAKRA - VISHUDDHI



## PRANA

PHYSICAL LOCATION- DIAPHRAGM TO THROAT (HEART)  
FUNCTIONS - RESPIRATION, SENSORY PERCEPTION  
CHAKRA - ANHATA



## SAMANA

PHYSICAL LOCATION- AT THE NAVEL  
FUNCTIONS - DIGESTION, METABOLISM, NOURISHING  
CHAKRA - MANIPURA



## VYANA

PHYSICAL LOCATION- PERVADES ENTIRE BODY (AURA)  
FUNCTIONS - CIRCULATION, NERVES  
CHAKRA - SWADHISTHANA



## APANA

PHYSICAL LOCATION- PELVIC FLOOR TO FEET  
FUNCTIONS - ELIMINATION, BIRTHING, MENSTRUATION  
CHAKRA - MULADHARA

# Did you know ??



@hindu\_rashtra108



**Anima (अणिमा) Siddhi is the first among the Ashta Siddhi (8 Supernatural Powers). It enables a person to be smaller even than the size of atom.**

**This power is possessed by Lord Hanuman. Marvel's Antman is the similar example of this who uses Anima Siddhi in the form of Pym Particles to be smaller than the size of atom. inspiration from rigveda**

# What Shiva Symbolizes

Trident represents the 3 powers - knowledge, desire and implementation

The Ganges signify the flow of scriptural teachings from one generation to the next

The moon symbolizes that the Lord is timeless

The third eye symbolizes destruction of evil and ignorance, if opened it reduces the person in vision to ashes

Serpent signifies ego which once mastered can be worn as an ornament

Drums symbolize sound representing the words from the Vedas

The tiger skin symbolizes fearlessness

Rudraksha beads denote purity

## Moon ☾

Wisdom is beyond the mind, but it needs to be expressed with a tinge of mind and this is symbolized by the crescent moon.

## Snake 🐍

The snake symbolizes alertness. To express this state of consciousness, a snake is shown around Lord Shiva's neck.

## Trident 🔱

Trishul signifies that Shiva is above all 3 states - waking, dreaming and sleeping, yet he upholds all 3 states.

## Third Eye 👁️

Alertness, knowledge and wisdom are all related to the third eye.

## Drum 🥁

It symbolizes the universe which is always expanding and collapsing. From an expansion it collapses and then it re-expands, this is the process of creation.

## Bull 🐃

It is a symbol of dharma (righteousness). Lord Shiva riding on the bull means that when you are truthful, the infinite consciousness is with you.

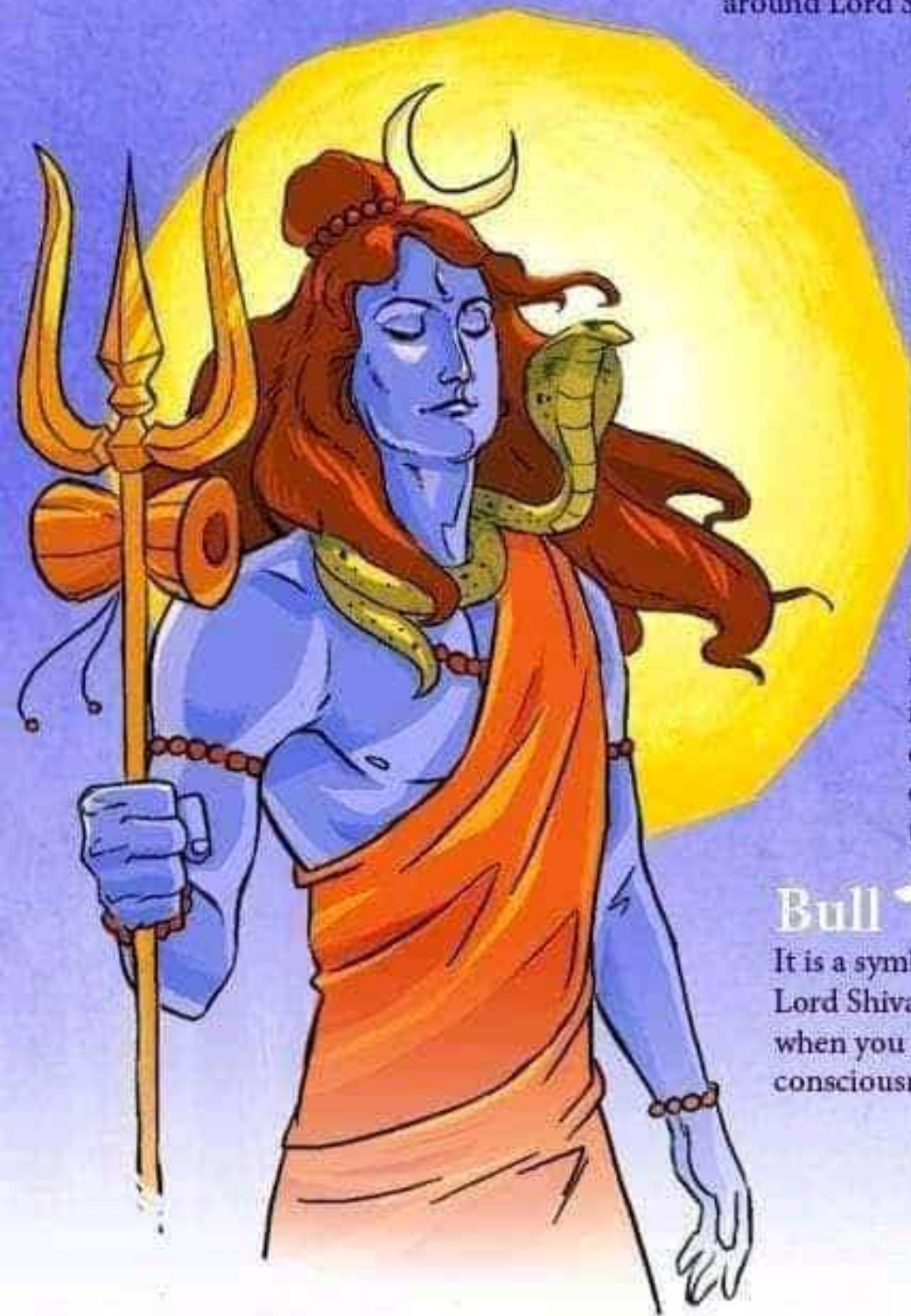

# SHIVA'S Adornments

why he wears what he wears

The moon is referred to as soma, the source of intoxication. Shiva has the moon because he's a great yogi who is intoxicated all the time, but he sits in great alertness. To enjoy intoxication, you must be alert. That's how yogis are – totally drunk, but fully alert.

## • MOON

The most significant aspect of Shiva is that he opened his third eye. What it means is, through these two eyes you can only see that which is physical. So this arousal of a new dimension of perception, through which one can perceive that which is beyond the physical, is referred to as

## • THE THIRD EYE

The snake indicates that Shiva's energies have reached the peak. Snake is a symbolism for kundalini, the unmanifest energy within you. A coiled-up snake is hard to see unless it moves. Kundalini is also such that only when it moves, you realize there is so much power within you.

## • SNAKE

Trishul symbolizes the three fundamental aspects of life. This can be called Pingala, Ida and Sushumna or man, woman and divine. These are the three basic nadis – the left, the right and the central – in the energy body of the human system.

## • TRISHUL

## • NANDI

Nandi symbolizes eternal waiting. One who knows how to simply sit and wait is naturally meditative. Nandi is sitting, very active, full of alertness, full of life, but just sitting that is meditation.

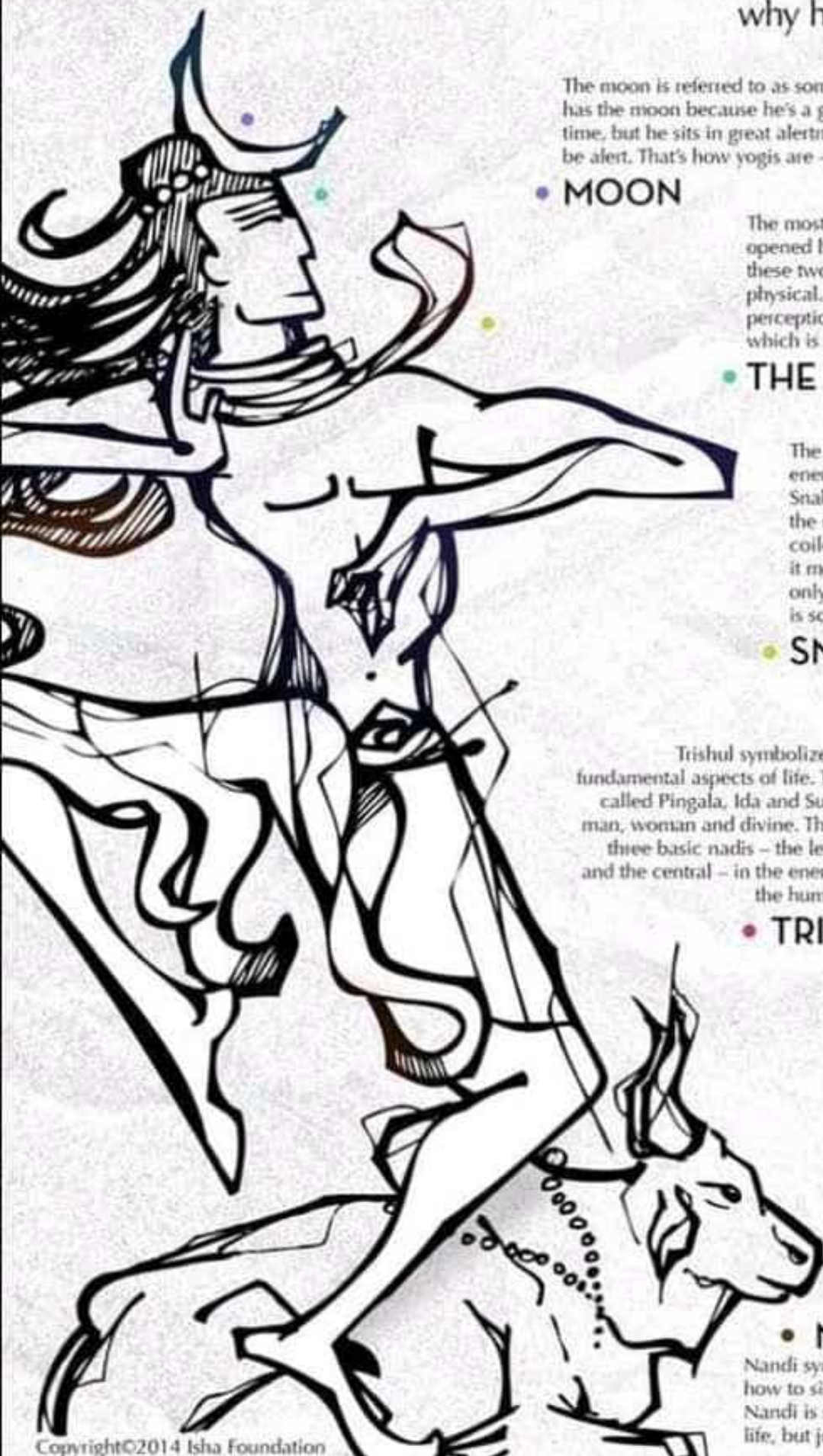

# Brahma

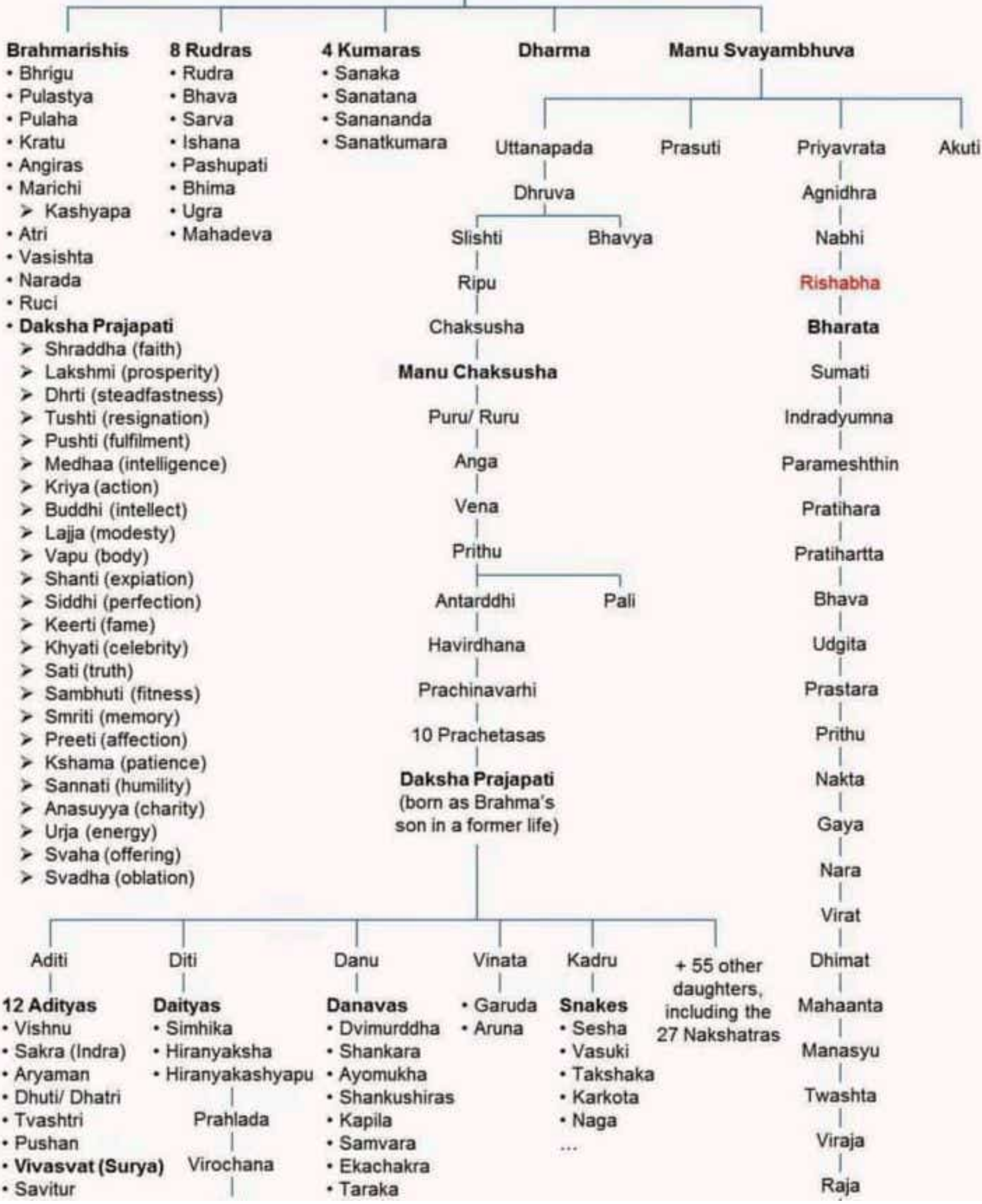



$\pi$

The great Indian mathematician Aryabhat calculated the value of pi at 3.1416

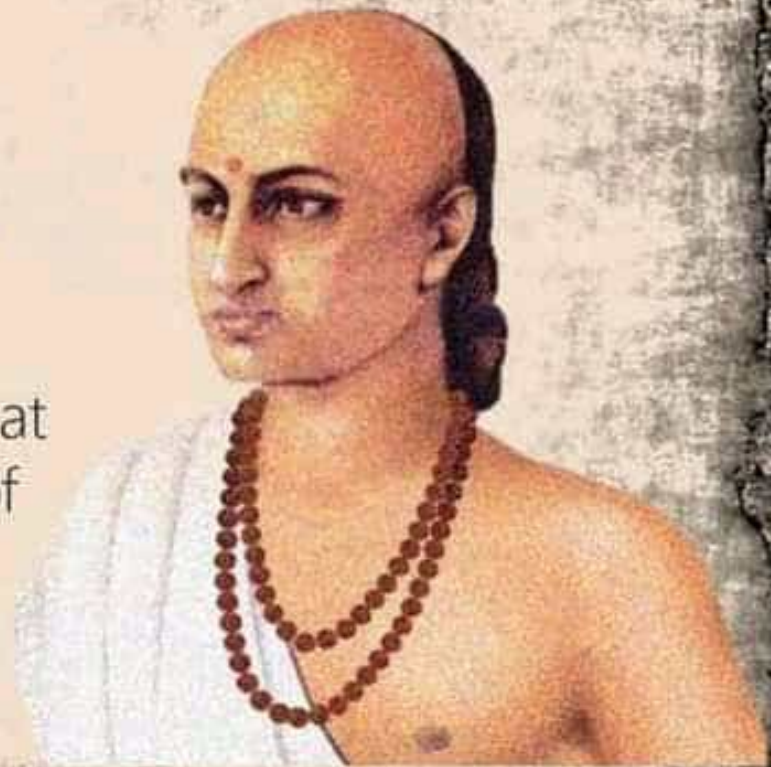

Aryabhata (476-529)

Did you know Trigonometry was invented by Vedic Sages in Ancient India.....???

You can not complete a simple short calculation in Vedic Astrology without the help of Trigonometry which is the study of the relationship between the angles of triangles and their sides

## PASCAL'S TRIANGLE

NAMED AFTER FRENCH  
MATHEMATICIAN  
BLAISE PASCAL

(1600)

			1						
		1	1						
	1	2	1						
	1	3	3	1					
	1	4	6	4	1				
1	5	10	10	5	1				
1	6	15	20	15	6	1			

## MERU PRASTARA

DERIVED FROM  
PINGALA'S  
FORMULA

(300 BCE)

वर्णखंडमेरुप्रस्थारम्भः

१						११११	
१	१					१११२	
१	२	१				१११३	
१	३	३	१			१११४	
१	४	६	४	१		१११५	
१	५	१०	१०	५	१	१११६	
१	६	१५	२०	१५	६	१११७	
१	७	२१	३५	३५	२१	७	१११८



Pingala,  
Indian mathematician  
3rd century BCE

THE  
DAILY  
SWITCH

**INDIA'S CONTRIBUTIONS  
TO MATHEMATICS NEED  
TO BE RECOGNIZED!**

# FINDING HELP IN THE BHAGAVAD GITA

Do you find yourself in any of the situations below?

## ANGER

- Chapter 2 - Text 56
- Chapter 2 - Text 62
- Chapter 2 - Text 63
- Chapter 5 - Text 26
- Chapter 16 - Text 1
- Chapter 16 - Text 2
- Chapter 16 - Text 3
- Chapter 16 - Text 21

## PRIDE

- Chapter 16 - Text 4
- Chapter 16 - Text 13
- Chapter 16 - Text 15
- Chapter 18 - Text 26
- Chapter 18 - Text 58

## LUST

- Chapter 3 - Text 37
- Chapter 3 - Text 41
- Chapter 3 - Text 43
- Chapter 5 - Text 22
- Chapter 16 - Text 21

## DISCRIMINATED

- Chapter 5 - Text 18
- Chapter 5 - Text 19
- Chapter 6 - Text 32
- Chapter 9 - Text 29

## DEPRESSION

- Chapter 2 - Text 3
- Chapter 2 - Text 14
- Chapter 5 - Text 21

## GREED

## FEELING SINFUL

- Chapter 4 - Text 36
- Chapter 4 - Text 37
- Chapter 5 - Text 10
- Chapter 9 - Text 30
- Chapter 10 - Text 3
- Chapter 14 - Text 6
- Chapter 18 - Text 66

## DEATH OF A LOVED ONE

- Chapter 2 - Text 13
- Chapter 2 - Text 20
- Chapter 2 - Text 22
- Chapter 2 - Text 25
- Chapter 2 - Text 27

## UNCONTROLLED MIND

- Chapter 6 - Text 5
- Chapter 6 - Text 6
- Chapter 6 - Text 26
- Chapter 6 - Text 35

## LAZINESS

- Chapter 3 - Text 8
- Chapter 3 - Text 20
- Chapter 6 - Text 16
- Chapter 18 - Text 39

## CONFUSION

- Chapter 2 - Text 7
- Chapter 3 - Text 2
- Chapter 18 - Text 61

## DEMOTIVATED

## PRACTISING FORGIVENESS

- Chapter 11 - Text 44
- Chapter 12 - Text 13
- Chapter 12 - Text 14
- Chapter 16 - Text 1
- Chapter 16 - Text 2
- Chapter 16 - Text 3

## SEEKING PEACE

- Chapter 2 - Text 66
- Chapter 2 - Text 71
- Chapter 4 - Text 39
- Chapter 5 - Text 29
- Chapter 8 - Text 28

## DEALING WITH ENVY

- Chapter 12 - Text 13
- Chapter 12 - Text 14
- Chapter 16 - Text 19
- Chapter 18 - Text 71

## LONELINESS

- Chapter 6 - Text 30
- Chapter 9 - Text 29
- Chapter 13 - Text 16
- Chapter 13 - Text 18

## FEAR

- Chapter 4 - Text 10
- Chapter 11 - Text 50
- Chapter 18 - Text 30

## TEMPTATION



# Idol Worship In Rig Veda

People having half or no knowledge and selfish people are trying to exploit Sanatani culture. It is hard for the people having zero knowledge to understand the Vedas.

Roots of idolatry are also found in Rig-Veda. It says that previously idols used to be made of wood. Wood decays fast. This is the reason ancient idols are not found these days and these people with no knowledge comment on idolatry.

It becomes clear from Rigveda (4.32.23) that idols were worshipped. Thus this hymn mentions the idolatry which is further described in Puranas.

## The Holy Grail

## LOCATION OF THE CHAKRAS

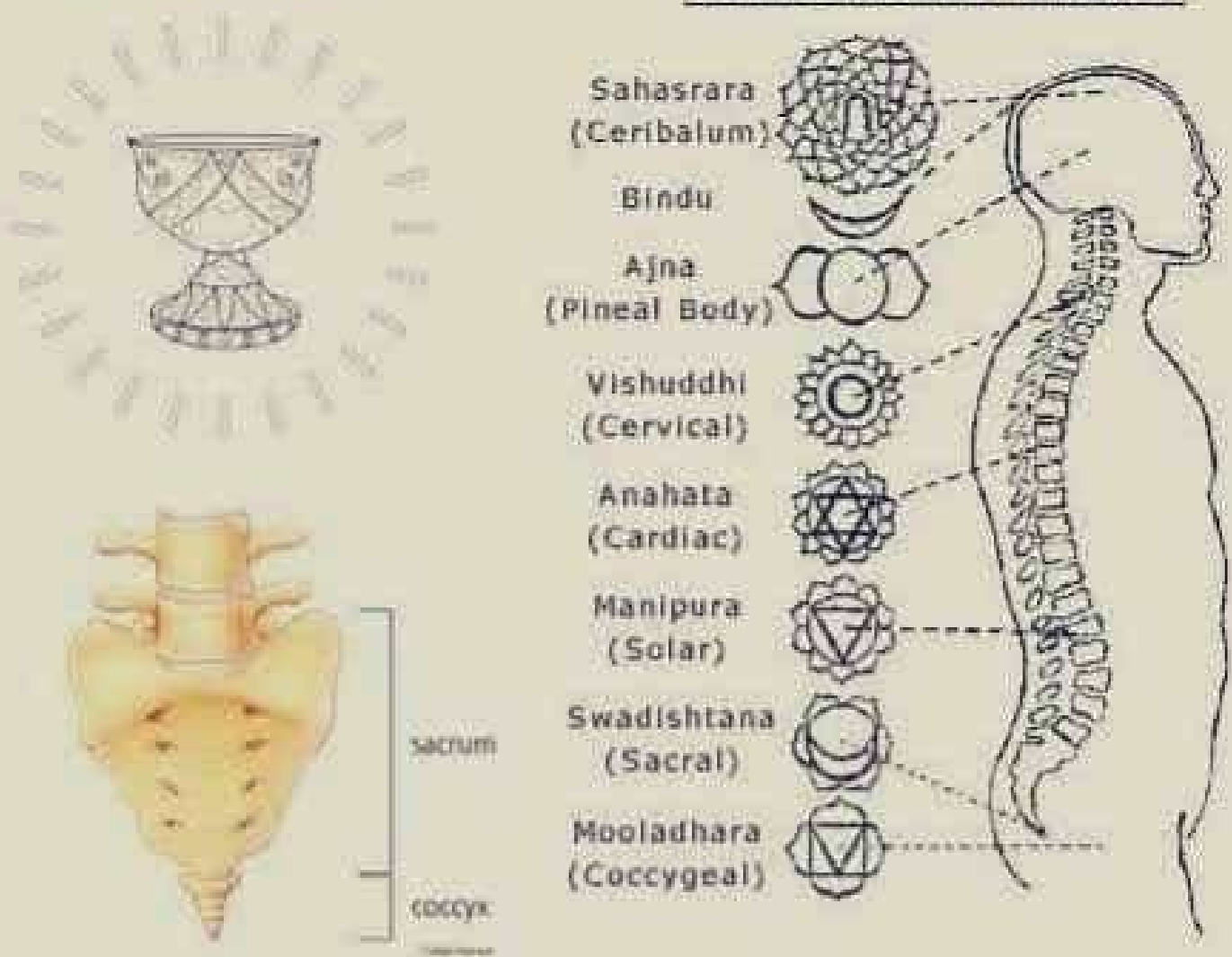

"The word Kundalini is derived from a Sanskrit word '**Kundal**' meaning coiled up.

It is the primordial dormant energy present in three-and-a-half, coils at the base of the spine in a triangular bone called the **Sacrum**.

The Latin name '**Os Sacrum**' suggests that it is a holy or sacred part of the body. The ancient Greeks were aware of this and therefore they called it the

# ALL YOU NEED TO KNOW ABOUT CHAKRAS

CHAKRAS ARE BACKBONE IN OUR SUBTLE SYSTEM,  
IT HELPS MANIFESTATION OF ENERGY INTO A FORM

YOU CAN CLEARLY IDENTIFY CHAKRAS IN OUR NERVOUS SYSTEM

[WWW.FACEBOOK.COM/MYSTIQINSIGHTS/](http://WWW.FACEBOOK.COM/MYSTIQINSIGHTS/)

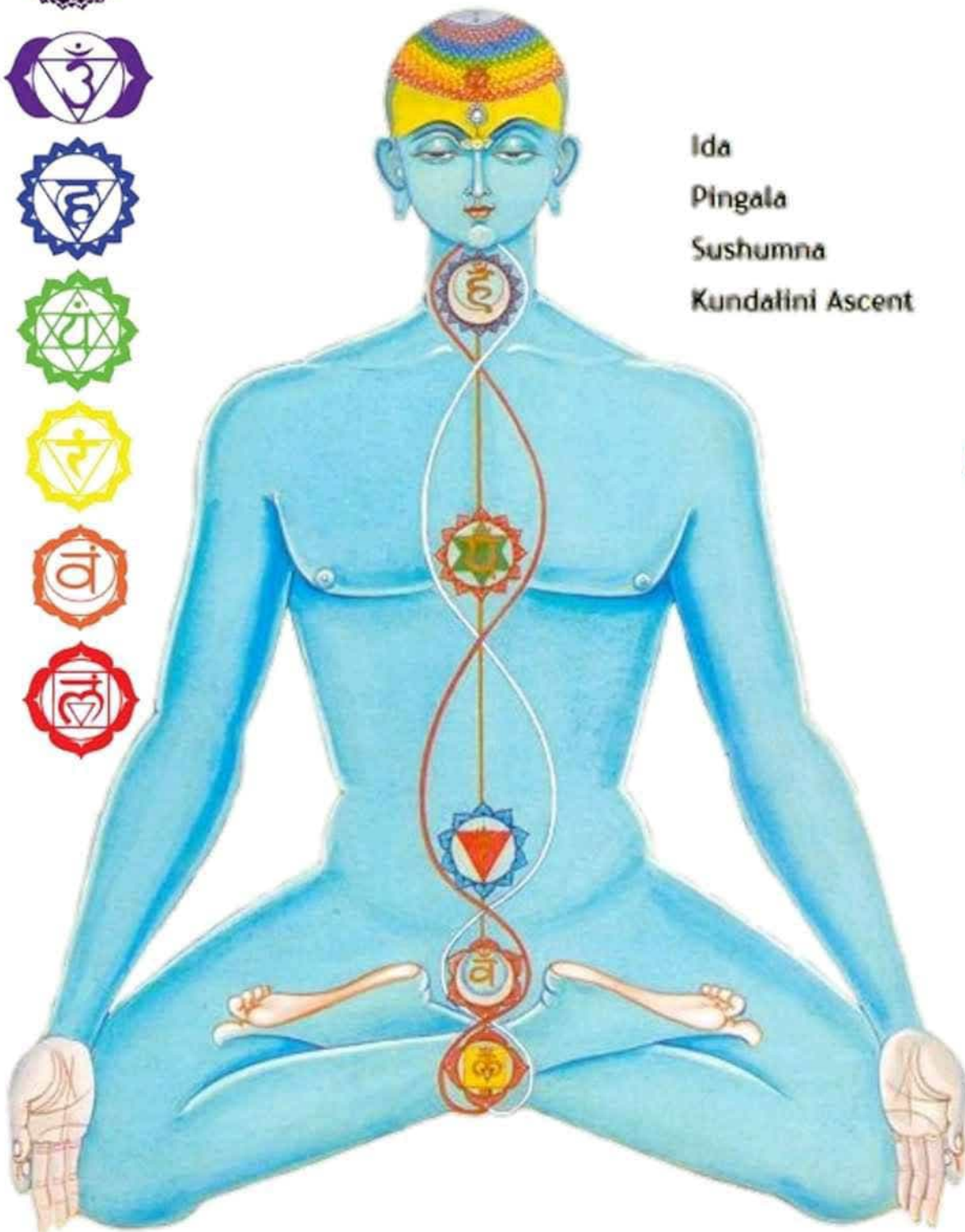

Ida  
Pingala  
Sushumna  
Kundalini Ascent

DHARMESH

#MYSTIQ\_INSIGHTS

**CHAKRAS ARE BACKBONE IN OUR SUBTLE SYSTEM,  
IT HELPS MANIFESTATION OF ENERGY INTO A FORM**

**YOU CAN CLEARLY IDENTIFY CHAKRAS IN OUR NERVOUS SYSTEM**

## **DETAILED CHART OF KUNDALINI FLOW**

**FOR IDA-PINGALA AND SHUSHUMNA**

**[WWW.FACEBOOK.COM/MYSTIQINSIGHTS/](http://WWW.FACEBOOK.COM/MYSTIQINSIGHTS/)**

**KUNDALINI  
--SIDE--**

The energy of the Kundalini flows through and around the spinal column all of the time in a maintenance pattern. On rare occasions, the full potential of the "sleeping serpent" is aroused and the maximum potential energy flow is released. This energizes the entire endocrine system, creating unusual physiological, mental, emotional and spiritual reactions.

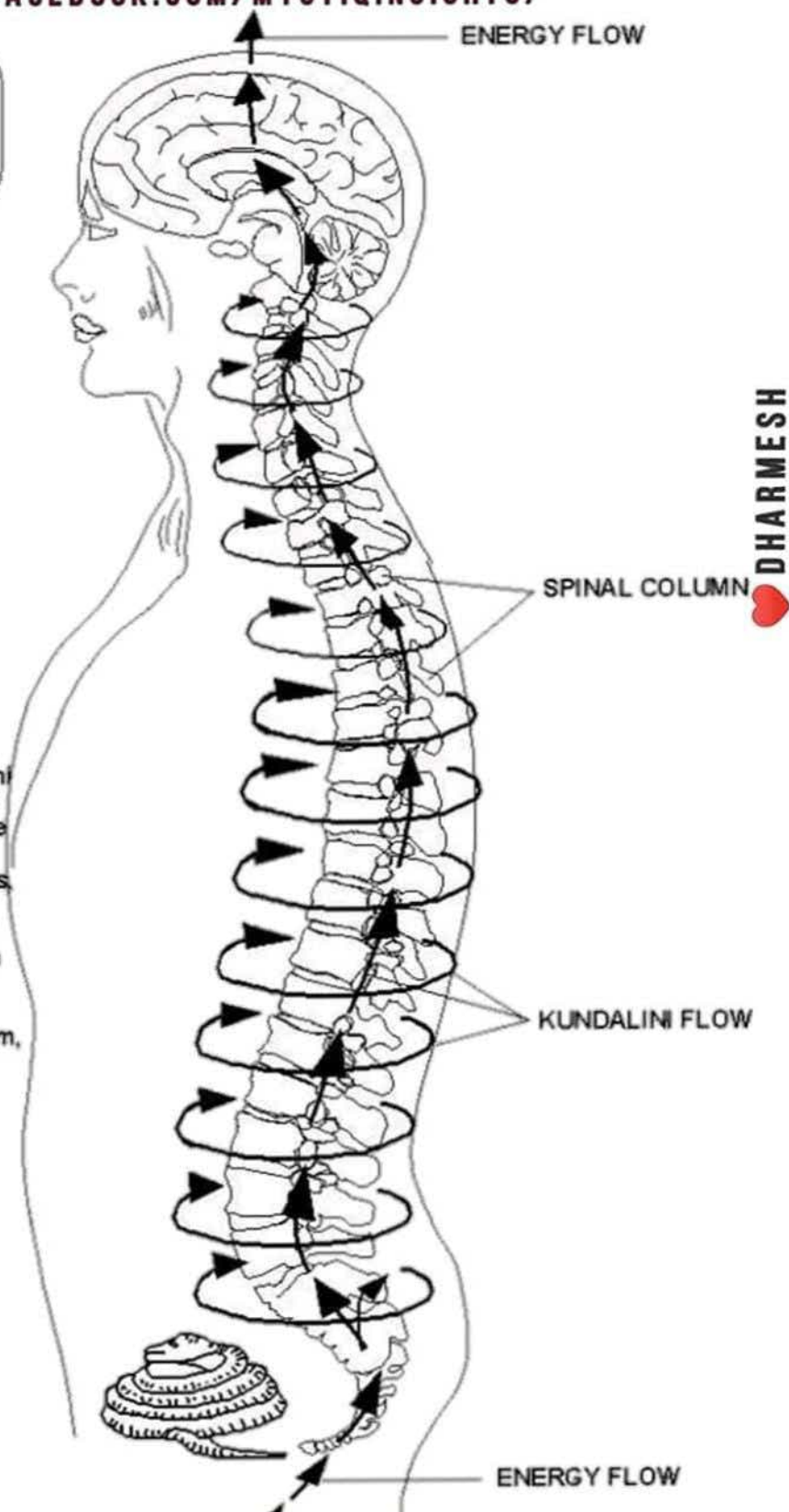

**DHARMESH**

**#MYSTIQ\_INSIGHTS**

# CHAKRAS ARE BACKBONE IN OUR SUBTLE SYSTEM, IT HELPS MANIFESTATION OF ENERGY INTO A FORM

YOU CAN CLEARLY IDENTIFY CHAKRAS IN OUR NERVOUS SYSTEM

WWW.FACEBOOK.COM/MYSTIQINSIGHTS/

## FIGURES

Symbols:- Bindu(∴), Ardhchandra (☺), रोधिनी (◁),  
 Naad(••), Naadant (••), Shakti (••), Vyapini (△)  
 Samana(•), Unmani (•)

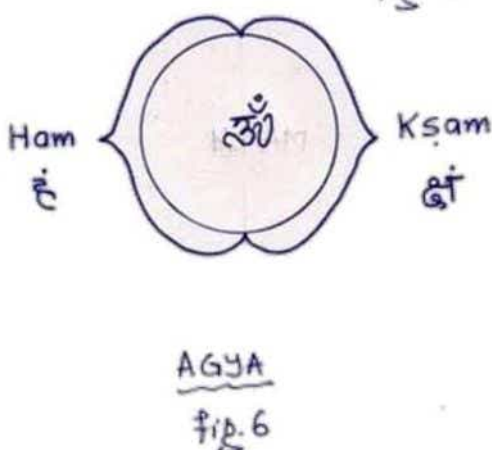
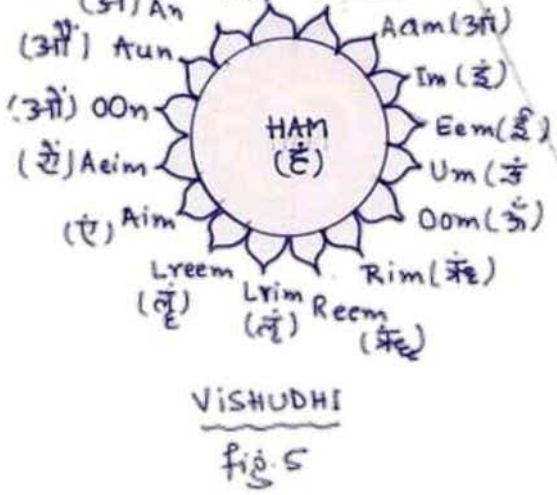
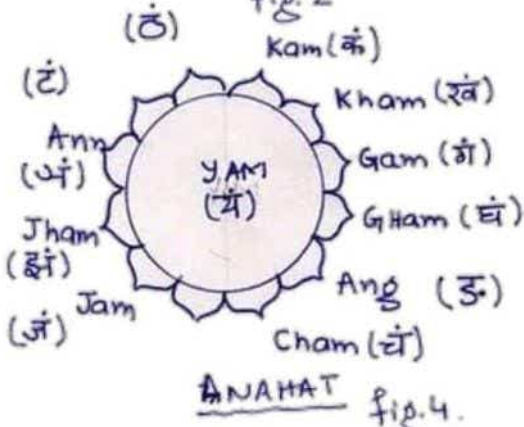
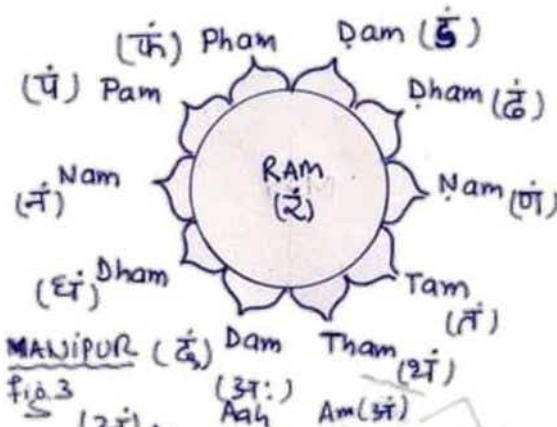
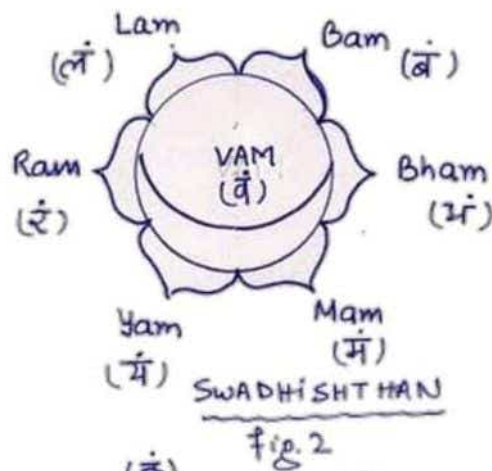
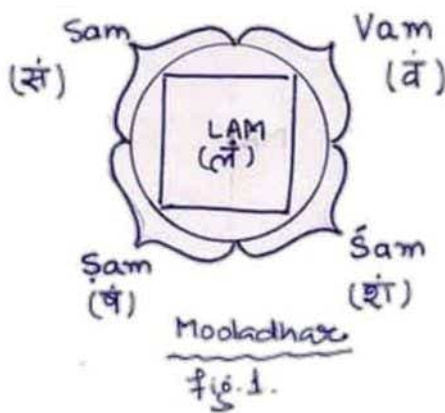

DHARMESH



# CHAKRAS ARE BACKBONE IN OUR SUBTLE SYSTEM, IT HELPS MANIFESTATION OF ENERGY INTO A FORM

YOU CAN CLEARLY IDENTIFY CHAKRAS IN OUR NERVOUS SYSTEM

## DETAILED CHART OF OUR SUBTLE SYSTEM

WWW.FACEBOOK.COM/MYSTIQINSIGHTS/

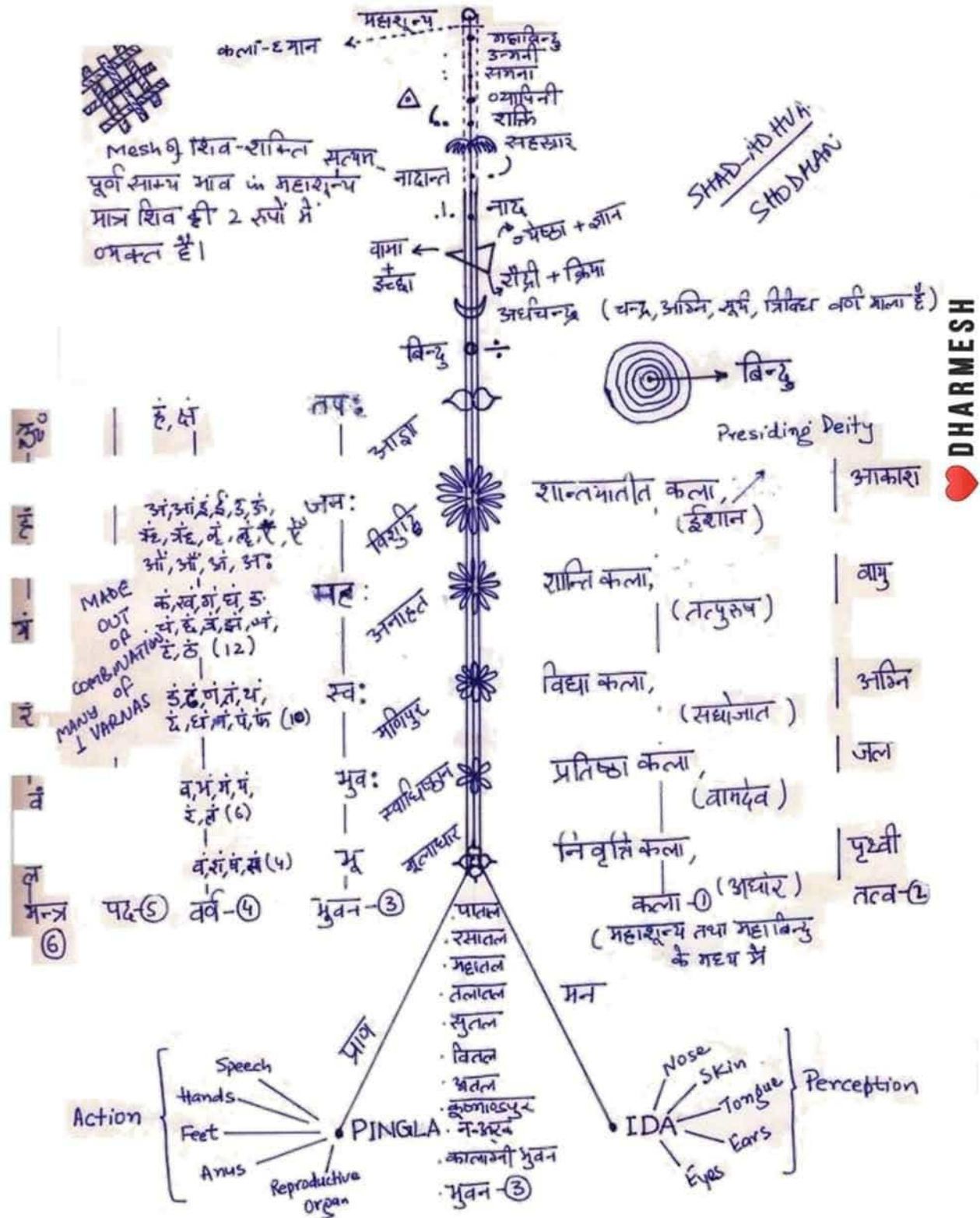

DHARMESH

**CHAKRAS ARE BACKBONE IN OUR SUBTLE SYSTEM,  
IT HELPS MANIFESTATION OF ENERGY INTO A FORM**

**YOU CAN CLEARLY IDENTIFY CHAKRAS IN OUR NERVOUS SYSTEM**

## **DETAILED CHART OF SAHASRARA CHAKRA**

[WWW.FACEBOOK.COM/MYSTIQINSIGHTS/](http://WWW.FACEBOOK.COM/MYSTIQINSIGHTS/)

### The Chakras in the Sahasrara

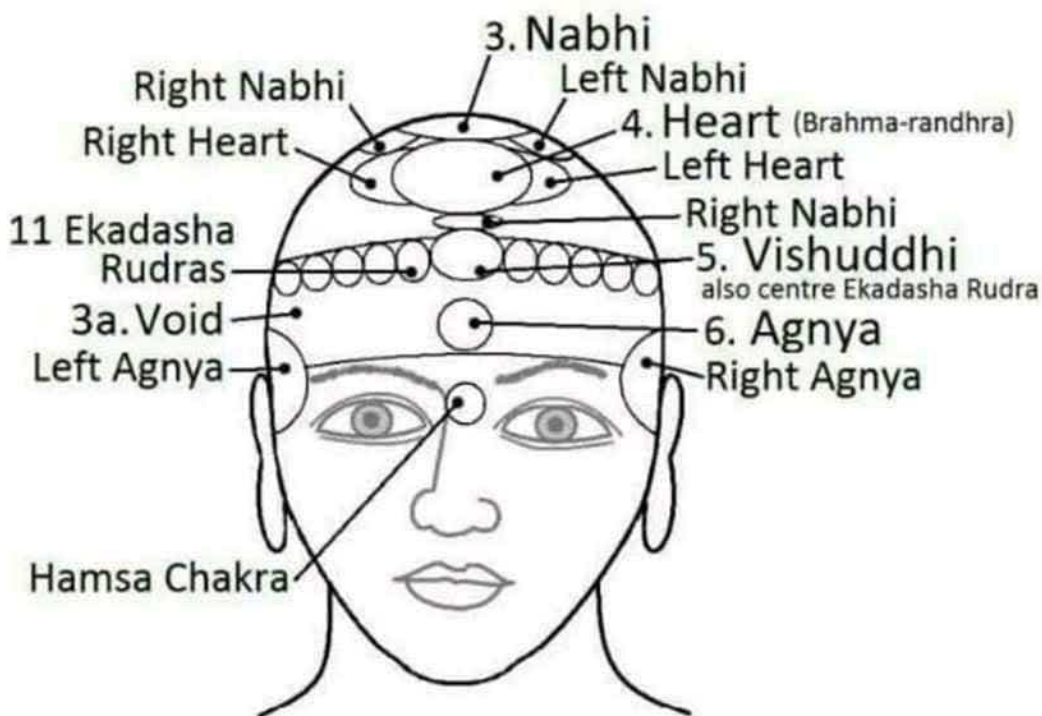

**DHARMESH**

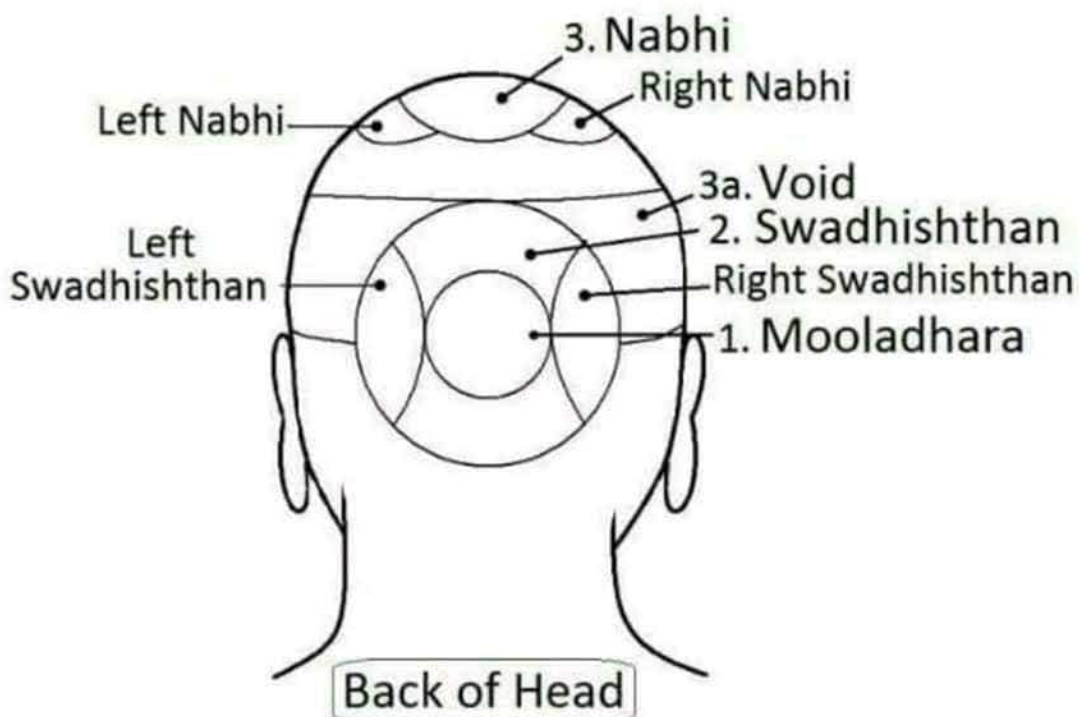

**#MYSTIQ\_INSIGHTS**

# CHAKRAS ARE BACKBONE IN OUR SUBTLE SYSTEM, IT HELPS MANIFESTATION OF ENERGY INTO A FORM

YOU CAN CLEARLY IDENTIFY CHAKRAS IN OUR NERVOUS SYSTEM

WWW.FACEBOOK.COM/MYSTIQINSIGHTS/

5 Kalas are <sup>in fact</sup> different states of Bindu only. Only Shantyalaksh Kala is non-agitated state of Bindu. Actually Shakti itself is MANTRA. Due to work differentiation it appears in 5 different states.

शान्तभातीत आधिष्ठात्र देव - ईशानः स्फटिक रत्न, विभूषित, जटी, मुळी, शिरकडी, अर्धमुण्ड कर्ण/वाष्पी/आमरा के नेत्र, सबसे बडे, क्षेत्रज्ञ में निवास

- शान्ति कला - तत्पुरुषः पीत वस्त्रधारि, प्रौढ, रूप-त्वक-वायु-के स्वाभि, गुणों के आक्रम रूप, सर्वज्ञ में अधिष्ठित | ५ पुत्र (२० कल्प)
- विद्या - सद्योजातः श्वेत-लोहित वर्ण, प्राण-उपस्थ-गन्ध-पृथ्वी का (२० कल्प) ईश्वर, ५ पुत्र-सुन्दर, नन्दन, विश्वनन्द, उपनन्द
- निवृत्ति - अधोरे काला, काल वस्त्र, फाडी टीका; ५ पुत्र कृष्ण, करिारव, कृष्णरत्न, कृ. कच्छ धनुः, रत्न, रूप, अभि; धर्म के लिए वृद्धि लाईत अङ्गों का विस्तार कर उसके रहना।
- प्रतिष्ठा - वामदेव लाल वस्त्र, माला, लाल नेत्र, लाल आभूषण | ५ पुत्र विरजा, विवाह, विश्व, विश्वमान | Represent प्ररकार, रसना/पापु/जल के स्वाभि; सदा अनेक प्रकार के कार्य करते हैं।

Jiva is bound by 3 snares. ① मल ② कर्म ③ माया. Some are bound by all three, some by two, some by one only.

मल - I am atma yet not free  
I am free but still bound by this body.

माया - called Yoni. All elements which give rise to भुवन, ईश, इन्द्रिया arise from it.

कर्म - with indriyas to perform & generate कर्म.

BASES OF ALL OF THESE ARE MATRIKAS

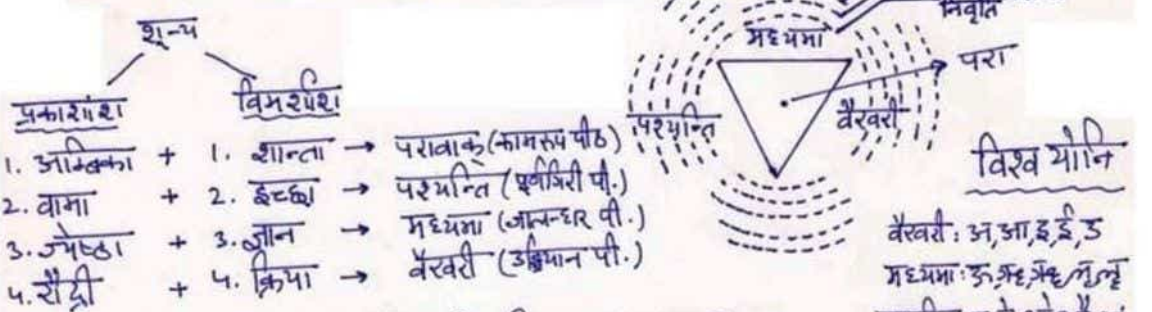

परा - चित्तशक्ति, अ; परापर - इच्छाशक्ति, ई; अपरा-ज्ञानश, उ  
When अ, इ, उ triad is disturbed, 6 shaktis come forth.

अं, आं, इं, ईं, उं, ऊं; and are called 6 शक्ति of Sun. All matrikas come out of them & their vibration itself is क्रिया शक्ति | गृह, ऋह, लृह, लृह are neuter gender and they cannot do srishiti. 64 Yoginis come

DHARMESH

# SHANKARACHARYA'S CONCEPT OF RELATIVITY

## HIS COMMENTARY TO VERSE 4.18 OF *BHAGAVADGITA*

श्रीमद्भगवद्गीता ४.१८

कर्मण्यकर्म यः  
पश्येत् अकर्मणि च  
कर्म यः स बुद्धिमान्  
मनुष्येषु...



**BHAGAVADGITA**

Chapter 4, verse 18  
"He who sees  
action (or motion)  
in inaction (or  
inertia); and he  
who sees inaction  
(or inertia) in  
action (or motion)  
is an intelligent one  
amongst humans."

Shankaracharya's commentary to this verse..

नौस्थस्य नावि गच्छन्त्यां तटस्थेषु अगतिषु नगेषु प्रतिकूलगतिदर्शनाद्  
दूरेषु चक्षुषा असन्निकृष्टेषु गच्छत्सु गत्याभावदर्शनात्

"A person going by boat will see the trees on the banks moving backwards, though they are stationary. However, he will see the heavenly bodies like the stars and planets above as stationary while they are in constant motion."

Thus, motion is relative, and so is everything in the universe.

RECENT SCIENTIFIC RESEARCHES>



## Early Astronomical References

यद्देवा यतयो यथा भुवनान्यपिन्वत ।  
अत्रा समुद्रआगूल् हमा सूर्यमजभर्तन ॥

When, O ye Gods, like Yatis,  
ye caused all existing things to grow,

Then ye brought Sūrya forward

who was lying hidden in the sea.

Rig Veda 10.72.7

उत्तस्य न उशिजामुर्विया कविरहिः शृणोतु बुध्योहवीमनि । सूर्यामासा विचरन्ता  
दिविक्षिता धिया शमीनहुषी अस्य बोधतम ॥

And may he too give ear, the Sage, from far away, the Dragon of  
the Deep, to this our yearning call.

Ye Sun and Moon who dwell in heaven and move in turn,  
and with your thought, O Earth and Sky, observe this well.

Rig Veda

10.92.12

एक एवाग्निर्बहुधा समिद्ध एकः सूर्यो विश्वमनु प्रभूतः ।  
एकैवोषाः सर्वमिदं वि भात्येकं वा इदं वि बभूव सर्वम ॥

Only one sun is the lord of the universe;  
one dawn gives light to the universe.

Rig Veda 8.58.2

## *The second stage of Vedic Calendar- 6000 BC*

कूष्ठो देवावञ्चिनाद्या दिवो मनावसू ।  
तच्छरवथो वृषण्वसू अत्रिर्वामा विवासति ॥  
कुत त्या कुह सुश्रुता दिवी देवा नासत्या । **Rig-Veda 5-74-1 & 2/2**

“Where in the heaven are you today, Gods, Ashvins, rich in consistency? Hear this, ye excellent bestowers: Atri invites you to come. Where are they now? Where are the Twain, the famed Nasatyas, gods in heaven”.

- Precession had moved the WS to *Revati* by 6000 BC. *Ashvinis* were no longer rising before the Sun at WS.



## The Lunar cycle

The Moon as seen from Earth

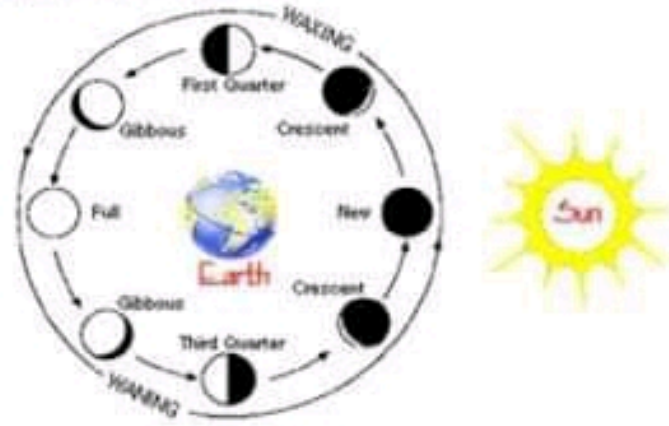

नवो-नवो भवति जायमानो.अहनां केतुरुषसामेत्यग्रं ।  
भागं देवेभ्यो वि दधात्यायन पर चन्द्रमास्तिरतेदीर्घमयुः ॥

He, born afresh, is new and new for ever  
Ensign (flag or mark) of days he goes before the Mornings  
Coming, he orders for the Gods their portion.  
The Moon prolongs the days of our existence.

Rig Veda 10.85.19

तृतीयाष्टकमाह—

अदृश्रमस्यकेतवोविश्मयोजनान् अनु । भ्राजन्तोअग्रयोयथा ॥३॥

अदृश्रम् । अस्य । केतवः । वि । रश्मयः । जनान् । अनु ।  
भ्राजन्तः । अग्रयः । यथा ॥ ३ ॥

अस्यसूर्यस्यकेतवःपञ्चापकाः रश्मयोदीपयः जनान्अनुव्यदृश्रंजावान्सर्वान्अनुक्रमेणये-  
क्षन्ते सर्वजगत्प्रकाशयन्तीत्यर्थः तवदृष्टान्तः— भ्राजन्तोदीप्यमानाः अग्रयोयथा अग्रयइव ॥ अ-  
दृश्रं दृशिःपेक्षणे वर्तमानेऽङ्गि इरितोवेतित्रेरेऽदेशः रुडित्यनुवृत्तौ बहुलंउन्दसीविरुडागमः अत-  
एवबहुलवचनात् ऋदृशोऽङ्गिगुणइतिगुणाभावइत्युक्तं तिङांतिङोभवन्तीतिप्रथमपुरुषबहुवचनस्य  
उत्तमपुरुषैकवचनादेशः प्रथमपुरुषएवशास्त्रान्तरेऽश्रूयते—अदृश्रन्नस्यकेतवइति । जनानित्य-  
स्पनकारस्यसंहितायांरुत्वयत्वादिपूर्ववत् । भ्राजन्तः शपःपित्वादनुदात्तत्वम् शतुश्चलसार्वधातु-  
कस्वरेणधातुस्वरएवशिष्यते ॥ ३ ॥

३. दीप्यमान अग्नि की तरह सूर्य की सूक्ष्म किरणों समूचे जगत्  
को एक-एक कर देखती हैं ।

चातुर्मास्येषुशुनासीर्यपर्वणिअस्तिसौर्यएककपालः तस्यतरणिरित्येषानुवाक्या तथाचसूत्रि-  
तम्—तरणिर्विश्वदर्शतश्चिन्देवानामुदगादनीकमितियाज्यानुवाक्याइति तथा अतिमूर्तिनाभ्ये-  
काहेऽङ्गणपक्षेसौरीष्टिःकर्तव्या तस्यामप्येषानुवाक्या अतिमूर्तिनेतिस्वण्डेसूत्रितम्—नवोनयोभ-  
वतिजायमानस्तरणिर्विश्वदर्शतइति ।

चामेतांसूकेचतुर्थीष्टकमाह—

तरणिर्विश्वदर्शतोज्योतिष्कृदसिसूर्य । विश्वमाभासिरोचनम् ॥४॥

तरणिः । विश्वदर्शतः । ज्योतिःकृत् । असि । सूर्य । विश्वम् ।  
आ । भासि । रोचनम् ॥ ४ ॥

हेसूर्य स्वंतरणिःतरिताअन्येनगन्तुमशक्यस्यमहतोऽध्वनोगन्तासि तथाचस्मर्यते—योजना-  
नांसहसेद्देशतेद्देशयोजने । एकेननिमिषार्धेनक्रममाणनमोस्तुतइति । यद्वा उपासकानारोगालां-  
रयितासि आरोग्यंभास्करादिच्छेदितिस्मरणात् । तथाविश्वदर्शतः विश्वैःसर्वैःप्राणिभिर्दर्श-  
नीयः आदित्यदर्शनस्यचाण्डालादिदर्शनजनितपापनिर्हरणहेतुत्वात् तथाचापस्तम्बः—दर्शने  
ज्योतिषांदर्शनमिति । यद्वा विश्वंसकलंभूतजातंदर्शतंद्दृष्टव्यंप्रकाशयनेनसतथोकः तथाज्यो-



# Speed of light



"Salutations to the sun, the traveler of 2202 Yojnas in half a Nimisha"

Rig Veda Samhita 1. 50. 4

The speed of light, according to the Vedas:

**185,016.169 miles/second**

Modern Value: 186,282.397 miles/second, by Klaus Roemer, a Danish Astronomer in 1676. Until this time, even great scientists like Newton assumed speed of light to be infinity.

# This is how sun holds the earth Mentioned in Rig-Veda

@SCHOOL\_OF\_VEDIC\_SCIENCE

न प्रमिये सवितुर्देव्यस्य तद्यथा  
विश्वं भुवनं धारयिष्यति ।  
यत्पृथिव्या वरिमन्ना स्वङ्गुरिः वर्ष्मन्  
दिवः सुवति सत्यमस्य तत् ।  
ऋग्वेदः ५.५४.४।

**Never underestimate the capabilities of the glorious Savita (the Sun). He is holding objects in space (*vishvam*) as he is holding the earth (*bhuvana*). How is the Sun holding the earth? The earth is huge. Yet, the sun has made a ring for himself (*svanguri*). How? He has made a ring and has set the earth in constant motion around him in space. This alone is the truth.**

Rig Veda 5.54.4

# When Someone says word Hindu Given by Non-Indians : You say

श्लोक : ॐकार मूलमंत्राढ्यः पुनर्जन्म दृढाशयः  
गोभक्तो भारतगुरुः हिन्दुहिंसनदूषकः।  
हिंसया दूयते चित्तं तेन हिन्दुरितोरितः।



अर्थ : ॐकार' जिसका मूल मंत्र है, पुनर्जन्म में जिसकी दृढ़ आस्था है, भारत ने जिसका प्रवर्तन किया है तथा हिंसा की जो निंदा करता है, वह हिन्दू है।

**Means : Om is whose base Mantra , Re-incarnation is inseparable belief , The one whose heritage is Indian and The one who denies violence is HINDU !!!!**

श्लोक : 'हिमालयात् समारभ्य यावत् इन्दु सरोवरम्।  
तं देवनिर्मितं देशं हिन्दुस्थानं प्रचक्षते ॥'- (बृहस्पति  
आगम)

अर्थात् : हिमालय से प्रारंभ होकर इन्दु सरोवर (हिन्द महासागर) तक यह देव निर्मित देश हिन्दुस्थान

Small text block, likely a watermark or reference note.

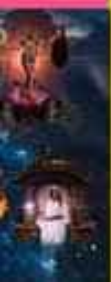

# MOON

OUR NATURAL SATELLITE



## Shloka:

Ayangauh prsnirakramidasadanmataram purah |  
Pitaranca prayantsvah |

Source: Rig Vedah, Mandalam 10, Suktam 189, Mantrah 1 (6000BCE)

## Meaning:

The moon being, a satellite of the earth, revolves around its mother planet and follows it in its revolution and self-luminous father planet( the Sun)

# WHY 108 IS IMPORTANT IN HINDUISM?

THE VEDIC COSMOLOGY STATES ,THE DISTANCE BETWEEN EARTH & SUN IS 108 TIMES THE DIAMETER OF SUN AND

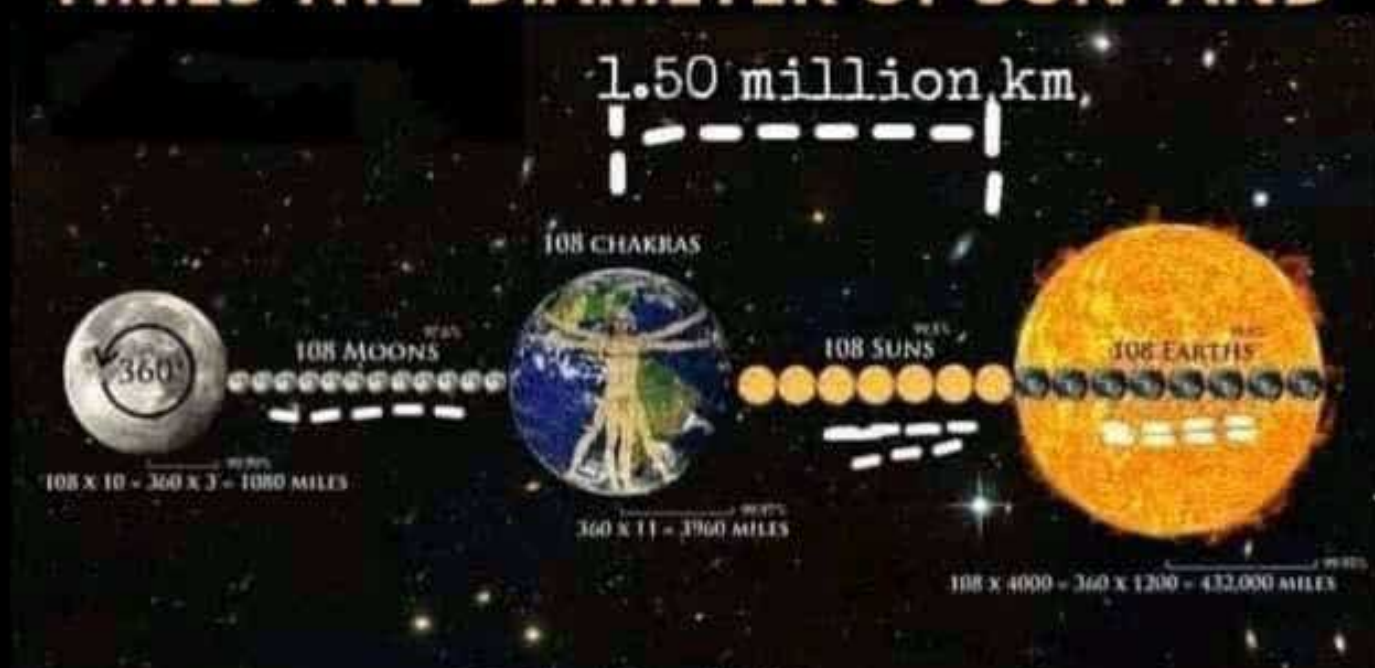

Holy No. 108 was given to us to reach any God.

Ancient science

$$1 \times 2 \times 3 = 108$$

VOZDURS

**DISTANCE BETWEEN EARTH & MOON IS 108 TIMES THE DIAMETER OF MOON.**

**SO, WHAT INDIAN ASTRONOMY SAID IN 10,000 BEFORE , NASA HAS PROVED IT ACCURATE TODAY. BE PROUD TO BE A PART OF THIS UNBELIEVABLE CULTURE.**

## 1. ऋग्वेद के बृहस्पति आगम में हिन्दू शब्द:

In Brihaspati Aagam

हिमालयं समारभ्य यावत् इन्दुसरोवरं ।

तं देवनिर्मितं देशं हिन्दुस्थानं प्रचक्षते ॥

Himālayaṁ samārabhya yāvat indu sarēāvaram

taṁ dēvanirmitaṁ dēśaṁ hindusthānaṁ pracakṣatē

हिमालय पर्वत से शुरू होकर भारतीय महासागर तक फैला हुआ इश्वर निर्मित देश को "हिंदुस्थान" कहा जाता है।

Starting from the Himalayan Mountains and extending to the Indian Ocean, God created country is called "Hindusthan",

## 2- Meru Tantra ( Shaive Aagam)

मेरु तंत्र ( शैव ग्रन्थ) में हिन्दू शब्द

‘हीनं च द्रुष्यत्येव हिन्दुरित्युच्यते प्रिये’

O My dear! One who renounced ignorance and inferiority is called a Hindu

## 3- Shabd Kalpdrum

यहीं परिभाषा 'शब्द कल्पद्रुम' में भी दोहराई गयी है

‘हीनं द्रुषयति इति हिन्दू’

जो अज्ञानता और हीनता का त्याग करे उसे हिन्दू कहते हैं

One who renounced ignorance and inferiority is called a Hindu



## Ashta Siddhi-8 Super powers mentioned in the Vedas

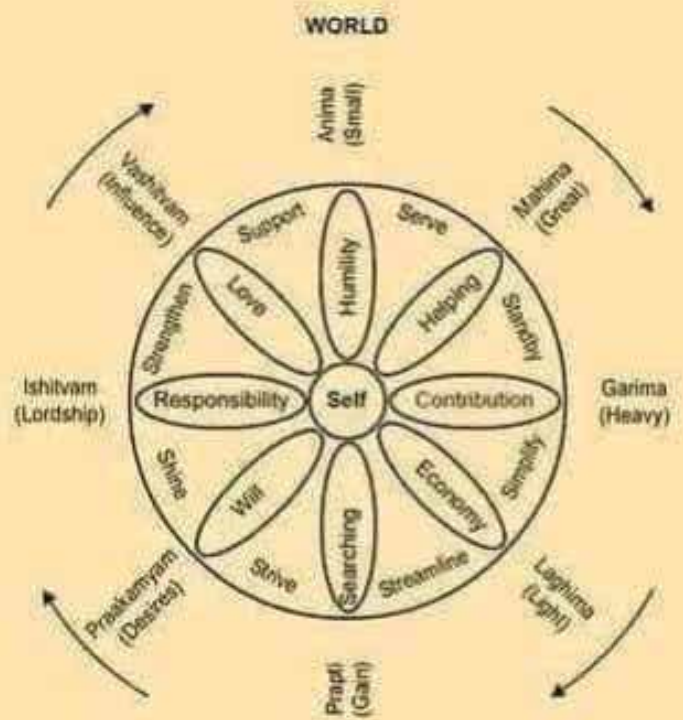

There are eight siddhis mentioned in our Vedic scriptures. The Scriptures also include the abilities gained by the seeker after the attainment of the Siddhis. The seeker needs to be very disciplined and learn to control the mind as it is not so easy to attain these siddhis. After attaining siddhis, the seeker rises above worldly attachment. Longing for desires of the materialistic world ends. It is said in the scriptures that Mata Sita blessed Lord Hanuman with eight siddhis and nine Nidhis. Anima, Mahima, Garima, Laghima, Prapti, Prakamya, Ishatva and Vastava. These Siddhis together are called "Ashtasiddhi." These Ashta Siddhis are also known as Brahma Pradana Siddhi (Divine attainments).

## 33 करोड़ या 33 कोटी देवी देवता ?

देवभाषा संस्कृत में कोटि के दो अर्थ है।

कोटि का एक अर्थ 'प्रकार' और एक अर्थ 'करोड़' भी है।

पर यहां कोटि का अर्थ प्रकार है।

ग्रंथो मे कुल 33 प्रकार के देवी-देवता का वर्णन मिलता है।

ये निम्न प्रकार से है:

12 आदित्य, 8 वसु, 11 रुद्र और इन्द्र व प्रजापति को मिलाकर कुल 33 देवता होते हैं। कुछ विद्वान इन्द्र और प्रजापति की जगह 2 अश्विनी कुमारों को रखते हैं। प्रजापति ही ब्रह्मा हैं।

### 12 आदित्य:-

1. अंशुमान, 2. अर्यमन, 3. इन्द्र, 4. त्वष्टा, 5. धातु, 6. पर्जन्य,
7. पूषा, 8. भग, 9. मित्र, 10. वरुण, 11. विवस्वान, 12. विष्णु

### 8 वसु:-

1. आप, 2. ध्रुव, 3. सोम, 4. धर,
5. अनिल, 6. अनल, 7. प्रत्यूष, 8. प्रभाष

### 11 रुद्र :-

1. शम्भु, 2. पिनाकी, 3. गिरीश, 4. स्थाणु, 5. भर्ग, 6. भव,
7. सदाशिव, 8. शिव, 9. हर, 10. शर्व 11. कपाली

### 2 अश्विनी कुमार:-

1. नासत्य, 2. दूस्त्र

कुल :  $12+8+11+2=33$



# Moolasthanam'



Hindu temples are built scientifically. The place where an idol is placed in the temple is called 'Moolasthanam'. This 'Moolasthanam' is where earth's magnetic waves are found to be maximum, thus benefitting the worshipper.

👤 Why do the bride and groom go round the fire 7 times in the marriage rituals?

Ans. Given by a Maths teacher:

Each circle consists of  $360^\circ$  .

The only number from 1 to 9 which cannot divide 360 is 7.

So the Bride and Groom go round the Fire 7 Times Ensuring that Nothing Can Divide Their Relationship.

🙏 MATHS 🙏

Hats off to our vedic maths 🙏 🙏

# DID YOU KNOW?

**MULTI UNIVERSE IS MENTIONED IN HINDU SCRIPTURES**



compare these

**athavā bahunaitena kiṃ jñātena tavārjuna  
viṣṭabhyāham idaṃ kṛtsnam ekāṃśena sthito jagat  
~(Srimad Bhagavatam 6.16.37)**

Every universe is covered by seven layers – earth, water, fire, air, sky, the total energy and false ego – each ten times greater than the previous one. There are innumerable universes besides this one, and although they are unlimitedly large, they move about like atoms in You. Therefore You are called unlimited.

Not just one but several Puranas, viz., Vishnu Purana, Srimad Bhagavatam, Padma Purana and Vayu Purana, and authoritative Hindu scriptures like Atharva Veda have spoken of the different universes.

# THINK ABOUT IT



Maurya Empire  
550 Years Old



Ahom Empire  
650 Years

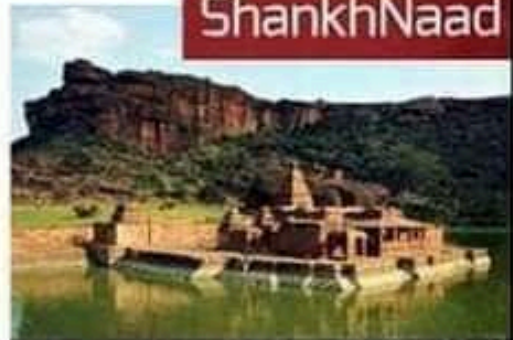

ShankhNaad

Chalukyas  
600 Years Old



Satvahanas  
500 Years Old



Chola Empire  
1000 Years Old



Pandya Empire  
800 Years Old



Chandela Empire  
400 Years Old



Gupta Empire  
400 Years Old



Pallava Empire  
600 Years Old

**But All We Learned In History Was  
How Great The Mughals Were**

Rig Veda  
had said 5000+ years ago  
what Copernicus found in 1541

ahastÁ yád apádl  
várdhata kSÁH  
sháclbhir vedyÁnAm  
shúSNam pári  
pradakSiNíd  
vishvÁyave ní  
shishnathaH

[Rig Veda 10.22.14]

Team Lost Temples

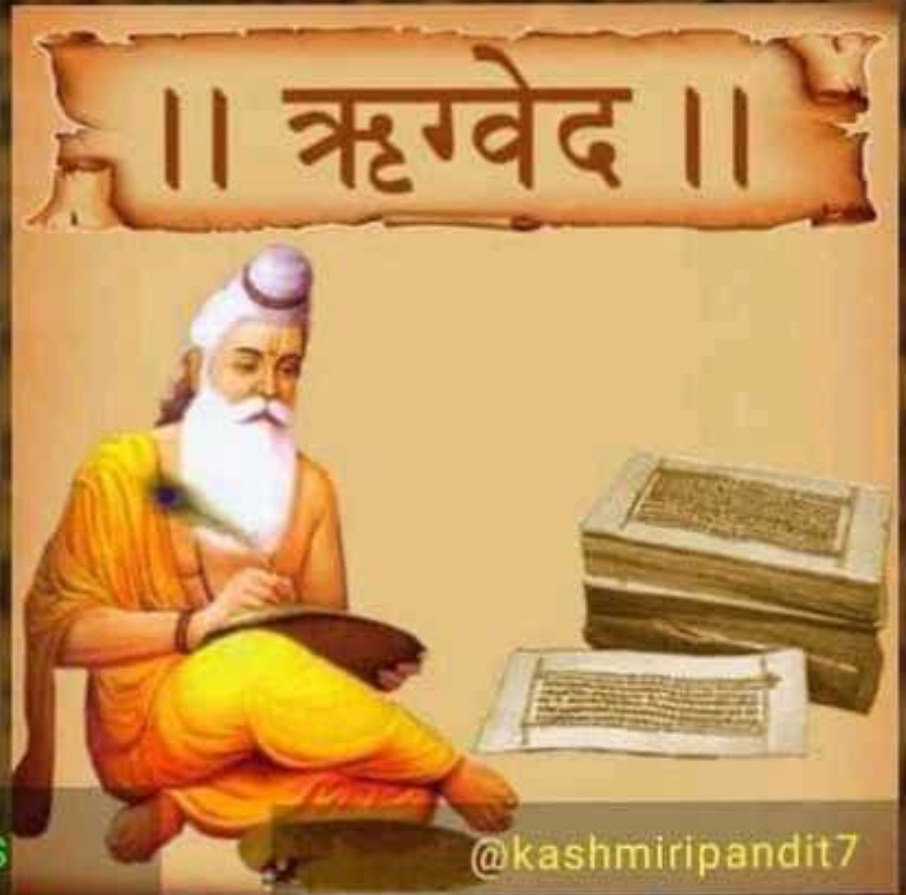

@kashmiripandit7

This earth is devoid of hands and legs, yet it moves  
ahead. All the objects over the earth also move with it.  
It moves around the sun